

**TECHNICAL MANUAL**

**WATERCRAFT EQUIPMENT  
CHARACTERISTICS  
AND DATA**

DISTRIBUTION STATEMENT A: Approved for public release; distribution is unlimited.

**\*This manual supersedes TM 55-500, dated 18 May 1992, including all changes.**

---

**HEADQUARTERS, DEPARTMENT OF THE ARMY  
30 AUGUST 1996**

TECHNICAL MANUAL

NO. 55-500

HEADQUARTERS  
DEPARTMENT OF THE ARMY  
WASHINGTON, D.C., 30 August 1996**WATERCRAFT EQUIPMENT  
CHARACTERISTICS  
AND DATA****REPORTING ERRORS AND RECOMMENDING IMPROVEMENTS**

You can help improve this manual. If you find any mistakes, or if you know of a way to improve these procedures, please let us know. Mail your letter or DA Form 2028 (Recommended Changes to Publications and Blank Forms), or DA Form 2028-2 located in the back of this manual directly to: Commander, US Army Aviation and Troop Command, ATTN: AMSAT-MP, 4300 Goodfellow Blvd., St. Louis, MO 63120-1798. You may so submit your recommended changes by E-mil directly to <mpmr%avma28@st-louis-emh7.army.mil>. A reply will be furnished directly to you. Instructions for sending an electron 2028 may be found at the back of this manual immediately preceding the hard copy 2028.

DISTRIBUTION STATEMENT A: Approved for public release; distribution is unlimited.

**TABLE OF CONTENTS**

		<b>PAGE</b>
CHAPTER 1	GENERAL	
	Purpose and Scope .....	1-1
	Classification of Army Watercraft Equipment .....	1-1
	Limitations .....	1-1
CHAPTER 2	U.S. ARMY WATERCRAFT EQUIPMENT	
Section I	General	
	Mission .....	2-1
	Description of Equipment.....	2-1
Section II	Key to Reference Data	
	Design Number and Specifications .....	2-2
	Designation Prefixes .....	2-2
	Description of Terms .....	2-3
	Computation Formulas.....	2-3
CHAPTER 3	GENERAL DATA AND ILLUSTRATIONS OF WATERCRAFT EQUIPMENT	
Section I	Propelling Unit .....	3-1
Section II	Harbor Craft .....	3-9
Section III	Landing Craft .....	3-74
Section IV	Amphibious Lighters .....	3-93
Section V	Causeway Systems.....	3-98
APPENDIX A	REFERENCES .....	A-1
APPENDIX B	INTERRELATIONS OF MEASUREMENTS.....	B-1
INDEX	.....	Index-1

\*This manual supersedes TM 55-500, dated 18 MAY 1992 including all changes.

## LIST OF ILLUSTRATIONS

<u>Item</u>	<u>Page</u>
Propelling unit, design 9002	3-4
Propelling unit, outboard, design NAV-165	3-6
Propelling unit, outboard, design (Thrustmaster)	3-8
Barge, deck or liquid cargo, non-propelled, knockdown, design 218E	3-11
Barge, deck cargo, non-propelled, ocean towing, 585 tons, design 231A	3-13
Barge, deck or liquid cargo, non-propelled, design 231B	3-15
Barge, liquid cargo, non-propelled, design 231C	3-17
Conversion kit, barge, deck enclosure	3-18
Crane, barge, 60-ton, design 413D	3-22
Crane, barge, 100-ton, design 264B	3-26
Barge, deck cargo, non-propelled, sectionalized, nesting, design. 7001	3-28
Barge, deck cargo, non-propelled, harbors and inland waterways, design 7005.	3-30
Pier, barge type, self-elevating, non-propelled, steel, 300 long, design 7029	3-32
Barge, water purification, non-propelled	3-34
Workboat, lifesaving and fire-fighting	3-36
Bridge erection boat	3-38
Boat, picket, design 4002	3-41
Boat, picket, des4n 4003	3-44
Boat, picket	3-46
Boat, passenger and cargo, design 2001	3-48
Boat, 65 ft., passenger, design 6013	3-50
High speed ferry, passenger	3-52
Repair shop, floating, marine equipment, non-propelled, design 7011	3-56
Tug, 600 hp, 100 ton, design 3004	3-59
Tug, 1200 hp, design 3006	3-62
Tug, 200 hp, design 320	3-65
Tug, river, 50 ft., shallow draft, design 3013	3-68
Inland and coastal large tug - 128 ft.	3-71
Tug, anchor handling / tug supply vessel	3-73
Landing craft, mechanized, 74 ft., LCM-8	3-81
Landing craft, utility, 135 feet, LCU-1667 & -1671 class	3-86
Landing craft, utility, 174 feet, LCU-2000 class	3-89
Logistics support vessel (LSV)	3-92
Lighter, amphibious, self-propelled, diesel, 60 ton, LARC-LX, design 2303	3-97
Roll-on / roll-off discharge facility (RO/RO)	3-100
Floating causeway system	3-103
Modular causeway section	3-105
Side loadable warping tug (SLWT)	3-107

## CHAPTER 1

### GENERAL

---

#### 1-1. Purpose and Scope.

a. This manual is published to provide a ready reference to those concerned with U.S. Army marine transportation activities. It gives the principal characteristics, capabilities, limitations, designs, classification, and primary functions of harbor craft, landing craft and amphibians.

b. This text is not intended to take the place of manuals covering specific items of equipment. All designs contained in the inventory are not listed for reasons of quantity, obsolescence, and usage.

c. The material in this manual is applicable to nuclear and non-nuclear warfare.

d. Uses of this manual are encouraged to submit recommended changes or comments to improve the manual. Comments should be keyed to the specific page, paragraph, and line of the text in which the change is recommended. Reasons should be provided for each comment to insure understanding and complete evaluation. Comments should be forwarded direct to the Commander, U.S. Army Aviation and Troop Command, 4300 Goodfellow Blvd., ATTN: AMSAT-I-WMP, St. Louis, MO 63120-1798.

#### 1-2. Classification of Army Watercraft

##### Equipment.

All Army watercraft are divided into classes based upon size and use. U.S. Army Regulations 56-9 sets forth the policy and responsibilities concerning the licensing and certification of Army military personnel for these watercraft.

a. Class A vessels are self-propelled and 65 feet or over in length.

b. Class B vessels are self-propelled and under 65 feet in length.

c. Class C vessels are all floating equipment which is not self-propelled, such as cranes, dry, and liquid cargo barges. This class is divided into two parts: Class C-1 non-propelled watercraft having berthing facilities and/or machinery on board; Class C-2 non-propelled watercraft having neither berthing facilities nor machinery.

#### 1-3. Limitations.

The information contained in this text on Army Watercraft equipment is current at the time of publication. Because of policies and techniques under study, design modifications are being made periodically and proposed functions of the craft may be altered. Where precise data are required, the "as-built" drawings, modifications, technical manuals and/or current-experience operating data pertaining to the particular item of equipment should be obtained.

## CHAPTER 2

U. S. ARMY WATERCRAFT EQUIPMENT

---

## Section I. GENERAL

## 2-1. Mission.

The mission of harbor craft, landing craft and amphibious units is to provide:

- a. Water transport for the movement of personnel and cargo between ship and shore and on inland waterways.
- b. Watercraft and other floating equipment to support terminal operations within a port or beach complex.
- c. Lighterage for movement of cargo and personnel from ships lying off-shore to transfer-segregation areas beyond the beach lines in amphibious and logistics over the shore (LOTS) operations.

## 2-2. Description of Equipment.

## a. Harbor Craft.

(1) Passenger and cargo, utility, and picket boats. Passengers and cargo boats and utility boats move limited amounts of cargo or small groups of personnel between ship and shore, or between two shore points. They are self-propelled and are capable of moderate speeds. Picket boats are used for command and inspection and for routine patrol missions in harbors and adjacent waters. They are capable of fairly high speeds and can make short trips to sea.

(2) Harbor tugs. Harbor tugs berth and un-berth large ships and move barges in harbors and adjacent waters. The predominant characteristics of harbor tugs are maneuverability, power, ample stability, and good cruising range. Limited Fire-fighting equipment is provided on all harbor tugs.

(3) Cargo vessels. Cargo vessels transport dry and liquid cargo. They have on-board machinery for propulsion of the vessel, and are equipped with gear suitable for loading and discharging the cargo they are designed to carry:

(4) Non-propelled barges and conversion kits. Non-propelled barges are of the dry or liquid cargo type. Liquid cargo barges have installed machinery for their purpose.: Dry cargo barges may be of hold, deck, or enclosed- deck types and may be used as nesting barges, work boats; or cargo lighters. Conversion kits for certain deck barge designs convert these vessels to covered barges for the protection of cargo.

(5) Floating cranes. Floating cranes are non- propelled vessels used in he loading and unloading of heavy lifts usually beyond the capacity of the ship 's cargo handling gear. Also, floating cranes may be used in salvage, dredging, and pile-driving operations.

(6) Floating repair shops. Floating repair shops are non-propelled vessels equipped and used for limited depot maintenance and repair of floating craft and amphibians.

(7) Self-elevating barge piers. Serf- elevating barges contain jacks, caissons, and the machinery for elevating themselves above water to form working platforms. Depending upon hydrographic conditions at the erection site, barges may be employed as single piers butted against a beach or as finger, marginal, T-head, or L-head piers.

b. Landing Craft. Landing craft are designed to beach, unload or load on the beach, and retract. Loading or discharging landing craft At de beach is expedited by the use of bow ramps. Landing craft are used in tactical and logistical operations, and for lighterage or utility work within harbors.

## c. Amphibious Lighters.

(1) Amphibious lighters are used to:

(a) Transport troops, equipment, and supplies from ships offshore to inland dumps and transfer points in tactical and logistical operations.

(b) Supply outposts located on nearby islands, or points inaccessible by land from the principal supply points.

(c) Evacuate- casualties and prisoners sites directly to ships.

(d) Transfer material from inland sites directly to ships.

(2) Amphibious lighters can traverse soft sand or rough terrain and can, operate on hard smooth surfaces at relatively high speeds. The larger models have ramps similar to landing craft to expedite loading or discharge.

## Section II. KEY TO REFERENCE DATA

### 2-3. Design Number and Specifications.

Adopted types of U.S. Army watercraft equipment have design number. More detailed information than that included in this text is contained in individual specifications.

### 2-4 Designation Prefixes.

Each item of harbor craft, landing craft, and amphibious equipment in the U.S. Army is identified by a hull number with a prefix consisting of one or more letters. The following is a list of prefixes with a brief description of the equipment they identify.

---

Prefix	Description
BC	Barge, dry cargo, non-propelled.
BCDK	Conversion kit, barge, deck enclosure.
BD	Crane, floating, 100 ton
BG	Barge, liquid cargo, non propelled, all sizes.
BK	Barge, dry cargo, non-propelled, knockdown.
BPL	Pier, barge type, self-elevating.
FMS	Repair shop, floating, marine repair, non-propelled, all sizes.
HLS	Heavy Lift Ship
J	Boat, work and inspection, small, 50 feet and under.
LARC	Lighter, amphibious, resupply, cargo.
LCM	Landing craft, mechanized.
LCU	Landing craft, utility.
LSV	Logistic support vessel.
LT	Tug, large, 100 feet and over.
Q	Boat, work and inspection, large, over 50 feet.
ST	Tug, small, under 100 feet
T	Freight and supply vessel, small, under 100 feet.
BEB	Boat, Bridge Erection
SLWT	Side Loadable Warping Tug
ROWPU	Reverse Osmosis Water Purification Unit
MCS	Modular Causeway System
RO/RO	Rob-On / Roll-Off Discharge Facility
FC	Floating Causeway
CF	Causeway Ferry

---

## 2-5. Description of Terms.

a. Displacement Ton. A unit of weight of sea water approximately equal to a long-ton, used in computing the displacement of watercraft, and equal to 35 cubic feet.

b. Displacement Tonnage, Light. The weight of a ship in long tons excluding cargo, passengers, fuel, water, stores, dunnage, and other items necessary for use on a voyage.

c. Displacement Tonnage, Loaded. The weight of a watercraft in, long ton, including cargo, passengers, fuel, water, stores, dunnage, and other items necessary for use on a voyage. It may also be defined as the total weight of the water displaced by the watercraft when in the above condition.

d. Deadweight Tonnage. The carrying capacity of a watercraft in long tons. It represents the difference between displacement tonnage, light, and the maximum displacement tonnage, loaded, Slowed by law.

e. Gross Ton. A unit of internal capacity used for ascertaining the legal or registered tonnage of watercraft; 100 cubic feet (2.8317 cubic meters).

f. Gross Tonnage. The entire internal cubic capacity of a watercraft expressed in gross tons, except certain spaces which are exempt, such as (1) peak and other tanks for water ballast, and (2) space above the upper-most continuous deck, such as open forecabin, bridge, and poop, certain light and air spaces, domes of skylights, condensers, anchor gear, steering gear, wheelhouse, galley, and passenger cabins.

g. Measurement Ton. A unit of volume for cargo computed at 40 cubic feet. Also called a freight ton, stevedore ton, or ship ton.

h. Net Tonnage. The tonnage most frequently used for the calculation of tonnage taxes and the assessment of charges for wharfage and other port dues. Net tonnage is the gross tonnage after deduction for space occupied by crew, machinery, fuel, and navigation of the watercraft. Also called net register tonnage.

## 2-6. Computation Formulas.

a. Fuel Consumption. The following equation is used in this text for computing the approximate hourly fuel consumption when other data is not available: 0.41 pounds of diesel fuel (pounds consumed per brake horsepower per hour) is multiplied by the total rated horsepower of the watercraft propulsion engine(s) plus the rated horsepower of one main generator engine. This figure is divided by 7.2 pounds (weight of 1 gallon of diesel fuel). Approximate hourly fuel consumption

$$(\text{gal}) = \frac{0.41 \text{ lb} \times \text{rated hp.}}{7.2 \text{ lb.}}$$

b. Running Time. The following equation is used in this text for computing the approximate hours of running time: fuel tank capacity 90 percent full) divided by fuel consumption per hour.

$$\text{Running time (hr)} = \frac{.90 \times \text{fuel tank capacity (gal)}}{\text{fuel consumption (gal per hr)}}$$

c. Cruising Range. The following equation is used in this text for computing cruising range: running time multiplied by the rated speed. Cruising range (nautical miles) = running time (hr) X speed (knots). Cruising range (statute miles) = running time (hr X speed (statute miles).

d. Cylindrical Tank Computations. The contents of a vertical or horizontal tank with plane ends may be determined by the following formulas where "D" is the diameter and "L" is the length in inches:

$$C = \frac{\pi}{4} \frac{D^2 L}{231} = .0034 D^2 L = \text{gallons per inch}$$

$$C = \frac{\pi}{4} \frac{D^2 L}{1728} = .0004545 D^2 L = \text{cubic feet per in.}$$

In computing the capacity of a tank with dished (convex) heads add 2/3 of the depth measurement of each head to the straight side length to obtain an approximate equivalent length of a tank with plane ends. The table below is used for determining the gallons or cubic feet in increments of inches.

**Table 1. Capacities of Horizontal Tanks**

Percent of depth	Percent of capacity	Percent of capacity	Percent of depth	Percent of depth	Percent of capacity
1	0.171	34	29.98	67	71.12
2	0.476	35	31.19	68	72.41
3	0.874	36	32.41	69	73.60
4	1.84	37	33.64	70	74.77
5	1.87	38	34.87	71	75.93
6	2.45	39	36.11	72	77.08
7	3.08	40	37.36	73	78.21
8	3.75	41	38.60	74	79.34
9	4.46	42	39.86	75	80.45
10	5.20	43	41.11	76	81.55
11	5.99	44	43.37	77	82.63
12	6.80	45	43.64	78	88.69
13	7.64	46	44.90	79	84.74
14	8.51	47	46.17	80	85.76
15	9.41	48	47.45	81	86.77
16	10.33	49	48.72	82	87.76
17	11.27	50	50.00	83	88.73
18	12.24	51	51.28	84	89.67
19	13.23	52	52.55	85	90.59
20	14.24	53	53.85	86	91.49
21	15.26	54	55.10	87	92.36
22	16.31	55	56.36	88	93.20
23	17.37	56	57.63	89	94.01
24	18.45	57	58.89	90	94.80
25	19.55	58	60.14	91	95.54
26	20.66	59	61.40	92	96.25
27	21.79	60	62.64	93	96.92
28	22.92	61	63.89	94	97.55
29	24.07	62	65.13	95	98.13
30	25.28	63	66.36	96	98.66
31	26.40	64	67.59	97	99.13
32	27.59	65	68.81	98	99.52
33	28.78	66	70.02	99	99.83
				100	100.00



CHAPTER 3  
GENERAL DATA AND ILLUSTRATIONS OF WATERCRAFT EQUIPMENT

---

Section I. PROPELUNG UNIT

**PROPELLING UNIT, DESIGN 9002**

PURPOSE: To propel barges and boats.

TRANSPORTABILITY: Can be shipped via modes of transportation.

## ADMINISTRATION INFORMATION

## DESIGNATION-

NSN - 2010-00-278-0793

ULN - P78995

COST - \$132,132 (June 1993)

## PRINCIPAL CHARACTERISTICS

## OPERATION DIMENSIONS AND WEIGHT

Overall length - 211 in.

Overall width - 64 in.

Overall height - 84 in.

Weight - 15750 lb

Depth - 128 in.

## SHIPPING DIMENSIONS:

## Chassis:

Overall length - 168 5/8 in.

Overall width - 64 in.

Overall height - (without wind dodger) 76 1/2 in.

## Outboard:

Overall length - 152 in.

Overall width - 53 in.

Overall height - 42 in.

Weight - (total) 15,750 lb

## Propelling Unit:

Model - Harbormaster OAC (TC)

## Capacities:

Fuel tank, engine - 155 gal.

Average operating time for fuel tank - 20 hours

Crankcase, engine - 31qt

Reverse gear - 3.75 qt

Thruster assembly- 64qt

## Engine:

Type - Diesel

Number of cylinders- 6

Crankshaft rotation(looking at aft end of engine forward) - Counterclockwise

## Power Takeoff Assembly:

Model number - PTA-3811

Hydraulic Marine Gear:

Oil Strainer

Type - Re-usable element

Starter:

Volts - 24

Generator:

Volts - 24

Generator Regulator:

Volts - 24

Amps - 20

Ground- Positive

Oil Filter:

Type - S2

Quantity - 2

Batteries:

Quantity - 4

Voltage per battery - 6 volts

Length- 16 1/4 in.

Width - 7 1/8 in.

Height - 7 1/4 in.

Fuel tank - 119 gal.

Hydraulic tank - 92 qt

Crankcase - 39 qt

Reverse gear housing - 8 qt

Swing joint - 160 qt

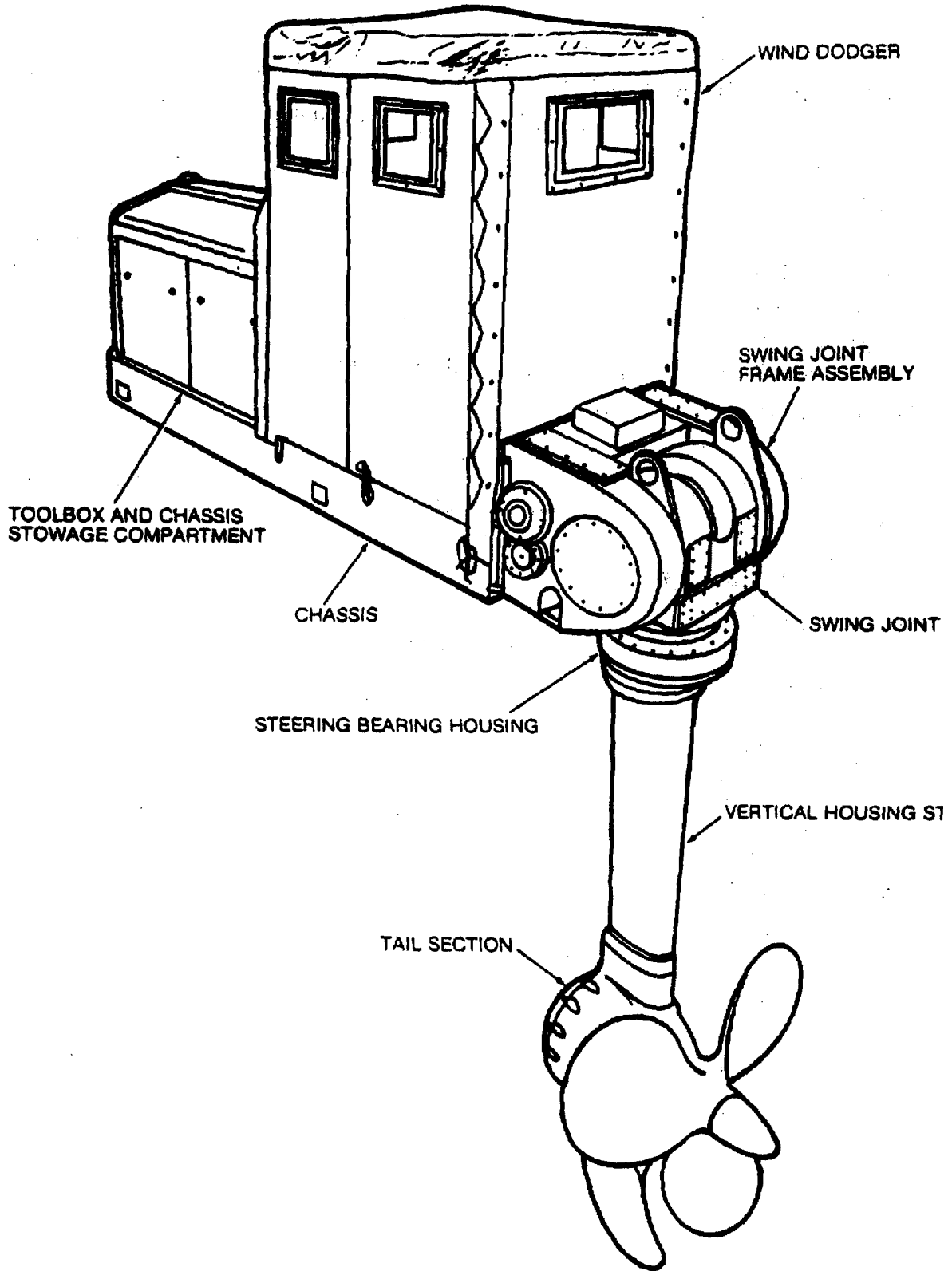

*Propelling Unit, Design 9002*

**PROPELLING UNIT, OUTBOARD, DESIGN NAV-165**

PURPOSE: To propel barges and boats.

TRANSPORTABILITY Can be shipped via all modes of transportation.

ADMINISTRATION INFORMATION

DESIGNATION -

NSN - 2010-00-410-4442

LIN - P78995

COST - \$132,132 (June 1993)

TYPE CLASSIFICATION

SPECIFICATION NO.

PRINCIPAL CHARACTERISTICS

OPERATION DIMENSIONS AND WEIGHT

Overall length- 203)in.

Overall width- 63 in.

Overall height (less thruster assembly) - 71 5/8 in.

Weight -

Depth adjustment - 30 in.

Propelling Unit:

Nomenclature - Propelling Unit, Outboard Diesel, 165 hp

Model - NAV- 165

Reverse Gear

Model - 5HD-200

Part number - 681111-5

Ratio: D to D

Thruster:

Model - SRP 154

Weight - 2600lb

Dimensions - 143 - 1/4 in. length

Torque - 1050 ft.

Propeller:

Pitch - 23 degrees

Number of blades - 3

Diameter - 37 h.

Rotation - Right hand

Weight - 150lb

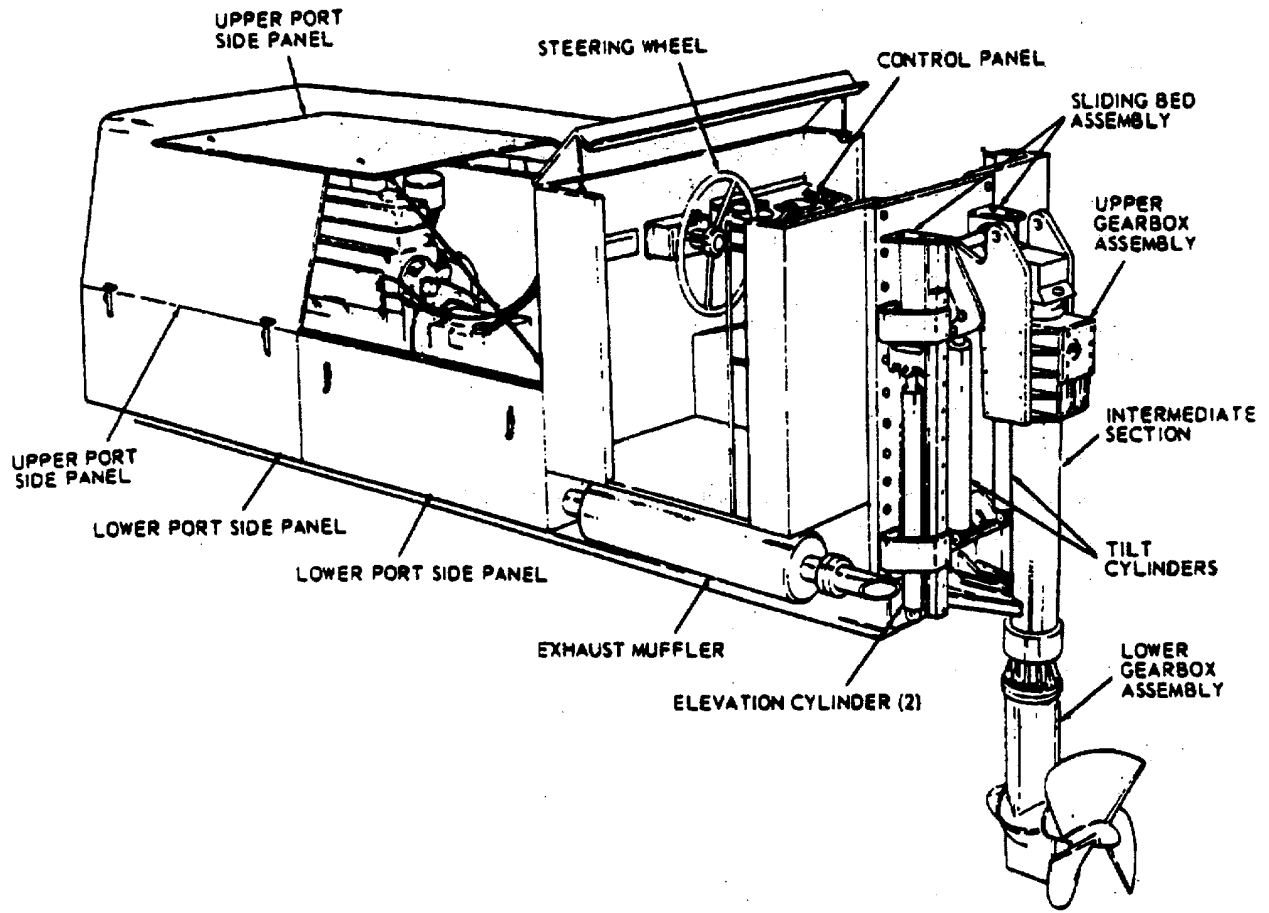

*Outboard Propelling Unit, Design NAV-165*

**PROPELLING UNIT, OUTBOARD, DESIGN (Thrustmaster)**

PURPOSE: To propel barges and boats.

TRANSPORTABILITY: Can be ship via all modes of transportation.

## ADMINISTRATION INFORMATION

DESIGNATION -

NSN - 2010-01-251-2227

LIN - P78995

COST - \$76,500 (June 1993)

TYPE CLASSIFICATION

SPECIFICATION NO.

## PRINCIPAL CHARACTERISTICS

## OPERATION DIMENSIONS AND WEIGHT

Overall length -16ft. 2 in. (m)

Overall width - 5 ft. 9 in. (m)

Overall height 14 ft. 3 in. (m)

Weight- 11,700bs. (kg)

Depth adjustment - 30 in.

## Propelling Unit:

Nomenclature - Propelling Unit Outboard Diesel, 165 hp

Model - Thrustmaster

## Hydraulic System:

Maximum propulsion pressure -4000 psi

Maximum charge pressure - 200 psi

Maximum steering pressure - 2000 psi

Maximum suction filter vacuum - 5 in. of mercury

Maximum discharge filter pressure - 15 psi

## Propeller

Pitch 32 degrees

Number of blades - 4

Diameter - 48 in.

## Engine:

Model number - 3208 DIT

Type - diesel

Number of cylinders - 8

Crankshaft rotation-clockwise

## Capacities:

Fuel tank, engine - 150 gal.

Crankcase, engine - 16 qts.

Coolant - 58 qts.

Thruster hydraulic system -55 gal.

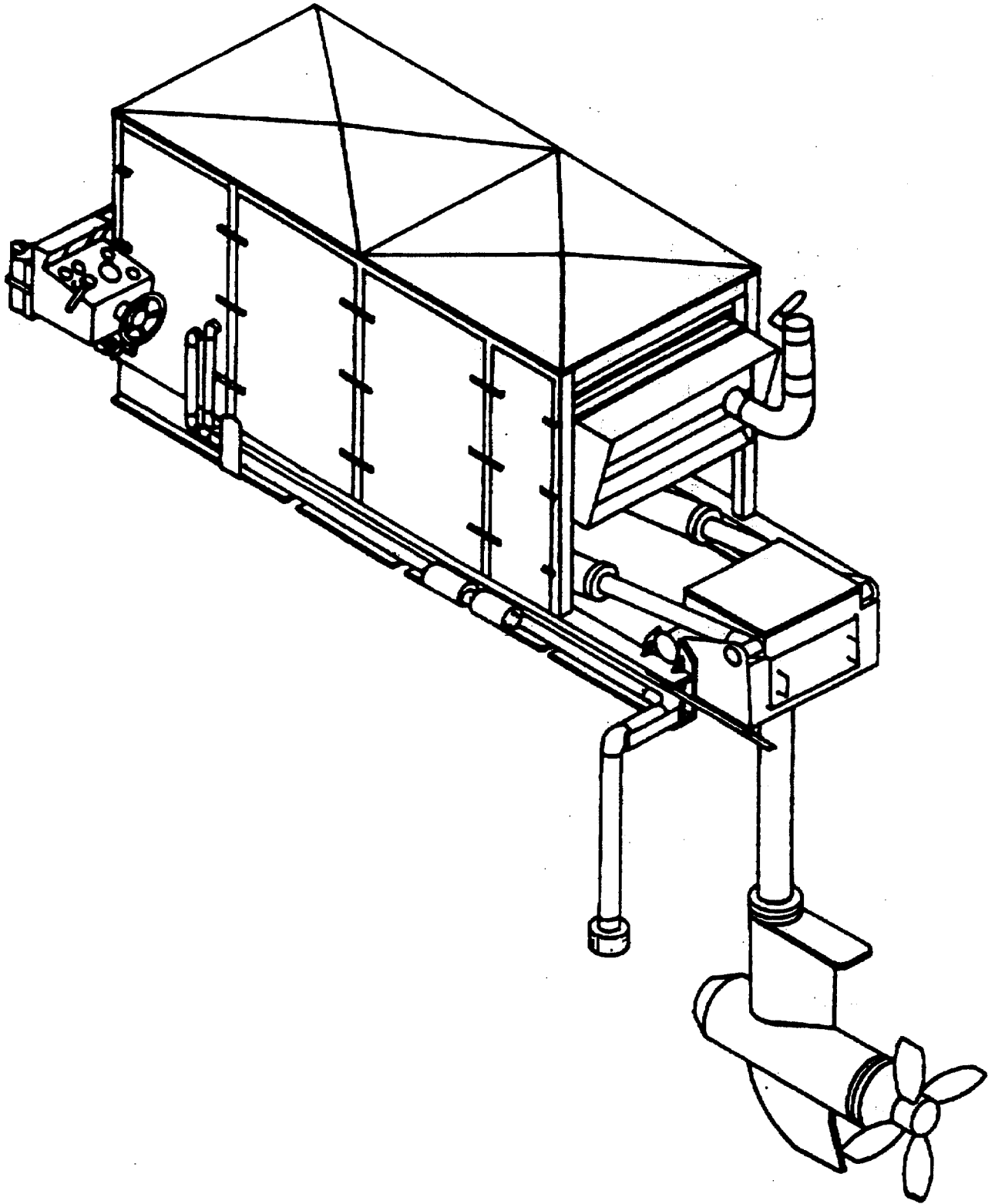

*Propelling Unit, Outboard, Design (Thrustmaster)*



**Section II. HARBOR CRAFT**

BARGE, DECK OR LIQUID CARGO, NON-PROPELLED  
KNOCKDOWN, DESIGN 218E

PURPOSE: To transport limited quantities of liquid or light, dry cargo out harbors and other inland waters. Secondary functions include use as a work barge or a small boat float.

TRANSPORTABILITY Can be sectionalized for shipment by rail marine transportation.

## ADMINISTRATION INFORMATION

DESIGNATION - BK

NSN- 1930-00-302-3910

LIN - B31334

COST - \$6,995 (June 1993)

TYPE CLASSIFICATION - STD-B

SPECIFICATION NO. - MIL-B-10775

## PRINCIPAL CHARACTERISTICS

## HULL AND ACCOMMODATIONS DATA:

Construction - This barge is of welded steel construction and consists of two coupled longitudinal sections giving the following dimensions:

Length, overall- 45 ft. 9 in. (139 meters)

Beam, molded - 18ft. (5.5 m)

Depth, molded - 3 ft. (92 cm)

## Displacement:

Light - 13 long tons (13.2 t.)

Loaded - 33 long tons (33.5 t.)

## Draft:

## Light:

Forward - 8 in. (20.3 cm)

Mean - 8 in. (20.3 cm)

Aft - 8 in. (20.3 cm)

## Loaded:

Forward - 8 in. (20.3 cm)

Mean - 1 ft. 8 in. (50.8 cm)

Aft - 1 ft. 8 in. (50.8 cm)

## Freeboard, mean:

Light- 2 ft. 4 . (71.1 cm)

Loaded - 1 ft. 4 in. (40.6 cm)

## Capacity:

Deck - 20 long tons (20.32 t)

Liquid - 225 barrels (35772L)

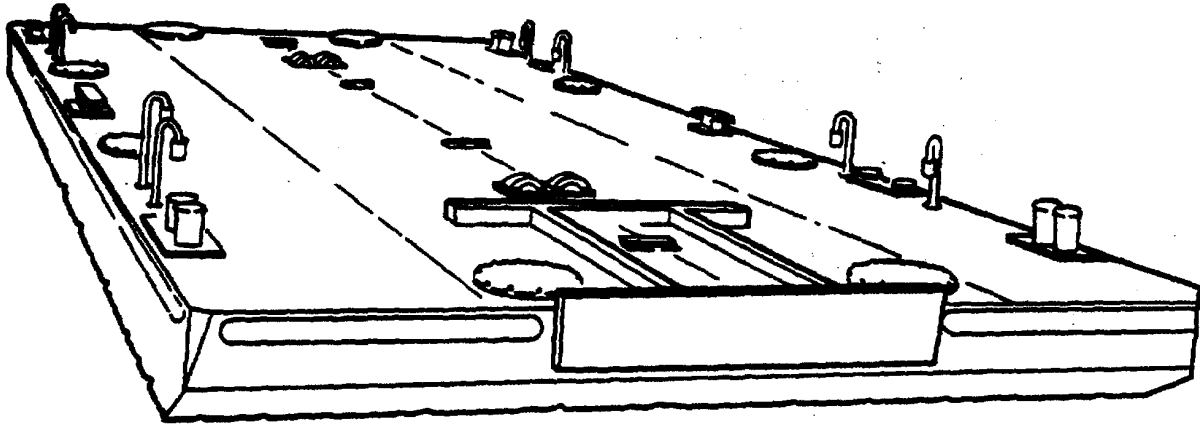

*Barge, Deck or Liquid Cargo, Non-propelled, Knockdown, Design 218E*

**BARGE, DECK CARGO, NON-PROPELLED  
OCEAN TOWING, 585 TONS, DESIGN 231A**

PURPOSE: To transport wheeled and tracked vehicles and general cargo in harbors and in and waters.  
TRANSPORTABILITY: Can be towed to overseas destination.

**ADMINISTRATION INFORMATION**

DESIGNATION - BOC  
NSN - 1930-00-375-2962  
LIN - B30923  
COST - \$77,800 (June 1993)  
TYPE CLASSIFICATION - STD-A  
SPECIFICATION NO. - MIL-B-10527

**PRINCIPAL CHARACTERISTICS****HULL AND ACCOMMODATIONS DATA:**

Construction - Steel. This barge is equipped with two skegs aft, making it suitable for towing with a minimum of yawing.

Length, overall- 142 t. (43.3 meters)

Beam, molded - 58 ft. (17.6 m)

Depth, molded - 12 ft. (3.6 m)

**Displacement:**

Light - 1132 long tons (1150 .)

Loaded - 760 long tons (721.t)

**Draft:****Light:**

Forward - 2 t. 4 in. (71.1 cm)

Mean - 2 ft. 4 in. (7 1.1 cm)

Aft - 2 ft 4 in. (71.1 cm)

**Loaded:**

Forward - 8 ft (2.4 m)

Mean - 8 ft. (2.4 m)

Aft - 8 ft. (2.4 m)

**Freeboard, mean:**

Light- 8 ft.2 n(2. 4 m)

Loaded - 2 ft. 6 in. (76.2 cm)

**Capacity:**

Cargo deck - 585 long tons (594.4 t)

**Anchors:**

Number- 2

Type - 300 (136.2 kg) "Danforth"

**Anchor Cables:**

Number- 2

Type- 50 fathoms (9L1.44 m); 1 in. (25.4 mm) steel

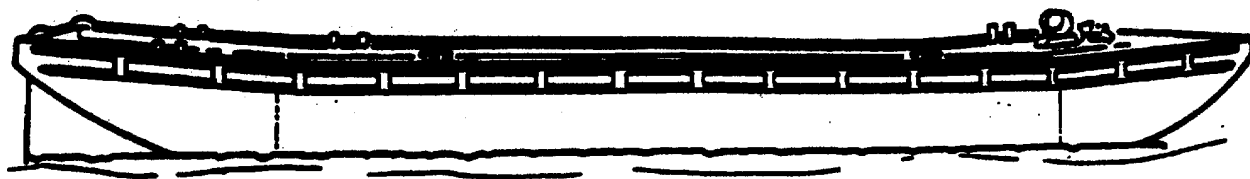

*Barge, Deck Cargo, Non-propelled, Ocean Towing, 585 Tons, Design 231A*

**BARGE, DECK OR LIQUID CARGO, NON-PROPELLED  
DESIGN 231B**

PURPOSE: To transport liquid general cargo or wheeled and tracked vehicles in harbors and inland waterways.

TRANSPORTABILITY: Can be towed to overseas destination.

**ADMINISTRATION INFORMATION**

DESIGNATION - BG

NSN - 1930-00-375-2972

LIN - B31197

COST - \$335,580 (June 1993)

TYPE CLASSIFICATION - STD-A

SPECIFICATION NO. - MILB-10122

**PRINCIPAL CHARACTERISTICS**

**HULL AND ACCOMMODATIONS DATA:**

Construction - Steel. This barge is equipped with two skegs aft, thereby improving its towing capabilities by the reduction of yawing. Barge designs 231-A and 231-B have similar hull dimensions.

Length, overall - 120 . (36.6 meters)

Beam, molded - 33 ft. (10 m)

Depth, molded - 10 ft. 6 in. (3.2 m)

**Displacement:**

Light - 185 long tons (188 t.)

Loaded - 763 long tons (775.2t.)

**Draft:**

**Light:**

Forward - 2 ft. 3 in. (68.5 cm)

Mean - 2 ft. 6 in. (76.2 cm)

Aft - 2 ft. 9 in. (83.8 cm)

**Loaded:**

Forward - 7 ft 6 in. (22 m)

Mean - 8 ft. 24 m)

Aft - 8 6 in. (25 m)

**Freeboard, mean:**

Light - 8 ft. 2 in. (2.4 m)

Loaded - 2 ft. 6 in. (76.2 cm)

**Capacity, cargo:**

Deck - 578 long tons (587.2 t)

Liquid - 4,160 barrels (rated)

Cargo tank No. 1 Stbd - 28,233 gals. (106,861.9 L)

Cargo tank No. 2 Port - 28,233 gals. (106,861.9 L)

Cargo tank No. 3 Stbd - 37,742 gals. (142,853.5 L)

Cargo tank No. 4 Port - 37,742 gals. (142,853.5 L)

Cargo tank No. 5 Stbd - 28,233 gals. (106,861. L)

Cargo tank No.6 Port - 28,233 gals. (106,861.9 L)

Total Capacity - 188,416 gals. (713,154.5 L)

Cargo pump - (1):

Type of drive - diesel

Capacity - 1,000 gallons per minute (3785 L per minute) (hulls BG 6087 through BG 6090)

Capacity - 1,050 gallons per minute (3974.2 L per minute) (all other hull numbers)

Size:

Suction - 8 in. (20.3 cm)

Discharge - 8 in. (20.3 cm)

Engine - (1):

Type - diesel

Horsepower - Three designs which vary according hull number:

77.8 hp @ 1200 rpm; 80 hp @ 1200 rpm; and 115 hp @ 1400 rpm;

Anchors - (2):

Type - 300 lb (136.2 kg) "Danforth"

Anchor Cables - (2):

Type - 50 fathoms (91.44 m); 1 in. (25.4 m) steel

Safety equipment:

Fire-fighting equipment:

Two 15 lb (6.8 kg) CO<sub>2</sub> cylinders

One 2-1/2 gal. (9.5 L) foam extinguisher

One 2-3/4 lb (1.2 kg) monobromotrifluoromethane charge hand extinguisher or equivalent

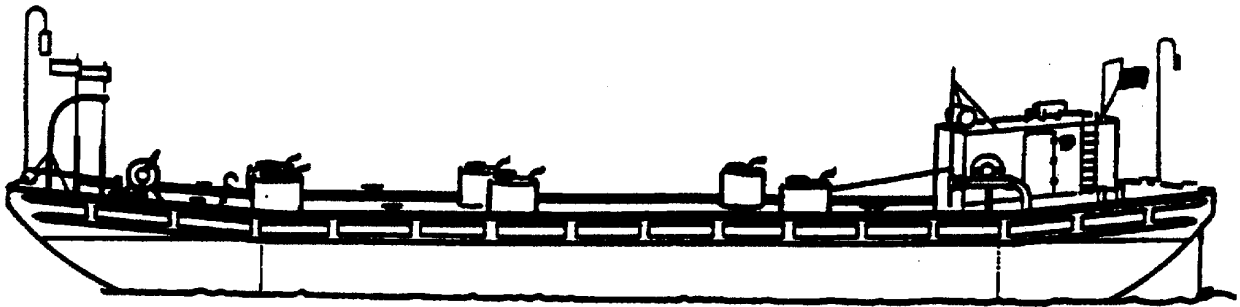

*Barge, Deck or Liquid Cargo, Non-propelled, Design 231B*

## BARGE, LIQUID CARGO, NON-PROPELLED DESIGN 231C

PURPOSE: To transport liquid for offshore, river, and intercoastal waterway service.

TRANSPORTABILITY: Can be towed to overseas destination.

### ADMINISTRATION INFORMATION

DESIGNATION - BG

NSN - 1930-01-313-9472

LIN - B31197

COST - \$335,580 (June 1993)

TYPE CLASSIFICATION - STD-A

SPECIFICATION NO. - MIL-B-10122

### PRINCIPAL CHARACTERISTICS

#### HULL AND ACCOMMODATIONS DATA:

Construction - Steel. This barge is equipped with two skegs aft, thereby improving its towing capabilities by the reduction of yawing. Barge designs 231-A and 231-B have similar hull dimensions.

Length, overall - 120 ft. (36.6 meters)

Beam, molded - 33 ft. (10 m)

Depth, molded - 10 ft. 6 in. (3.2 m)

#### Displacement:

Light - 185 long tons (188.0 t.)

Loaded - 763 long tons (775.2 t.)

#### Draft:

##### Light:

Forward - 2 ft. 3 in. (68.5 cm)

Mean - 2 ft 6 in. (76.2 cm)

Aft - 2 ft 9 in. (83.8 cm)

##### Loaded:

Forward - 7 ft. 6 in. (2.2 m)

Mean - 8 ft. (2.4 m)

Aft - 8 ft 6 in. (2.5 m)

#### Freeboard, mean:

Light - 8 ft. 2 in. (2.4 m)

Loaded - 2 ft. 6 in. (76.2 cm)

#### Capacity, cargo

Deck - 578 long tons (587.2 t)

Liquid - 160 barrels (rated)

Cargo tank No. 1 Stbd - 28,233 gals. (106,861.9 L)

Cargo tank No. 2 Port - 28,233 gals. (106,861.9 L)

Cargo tank No. 3 Stbd - 37,742 gals. (142,853.5 L)

Cargo tank No. 4 Port - 37,742 gals. (142,853.5 L)

Cargo tank No. 5 Stbd - 28,233 gals. (106,861.9 L)

Cargo tank No. 6 Port - 28,233 gals. (106,861.9 L)

Total Capacity - 188,416 gals. (713,154.5 L)



## Cargo pumps:

Number- 1

Type of drive - diesel

Capacity - 1,050 gallons per minute (3974.2 L per minute)

Size:

Suction - 8 in. (20.3 cm)

Discharge - 8 in. (20.3 cm)

## Engine:

Number - 1

Type - diesel

Horsepower - 120 hp @ 1890 rpm

## Anchors:

Number - 2

Type - 300 lb (136.2 kg) "Danforth"

## Anchor Cables:

Number - 2

Type - 50 fathoms (91.44 m); 1 in. (25.4 mm) steel

## Safety equipment:

Fire-fighting equipment:

Two 15 lb (6.8 kg) CO<sub>2</sub> cylinders

One 2-1/2 gal. (9.5 L) foam extinguisher

One 2-3/4 b (1.2 kg) monobromotrifluoromethane charge hand extinguisher or equivalent

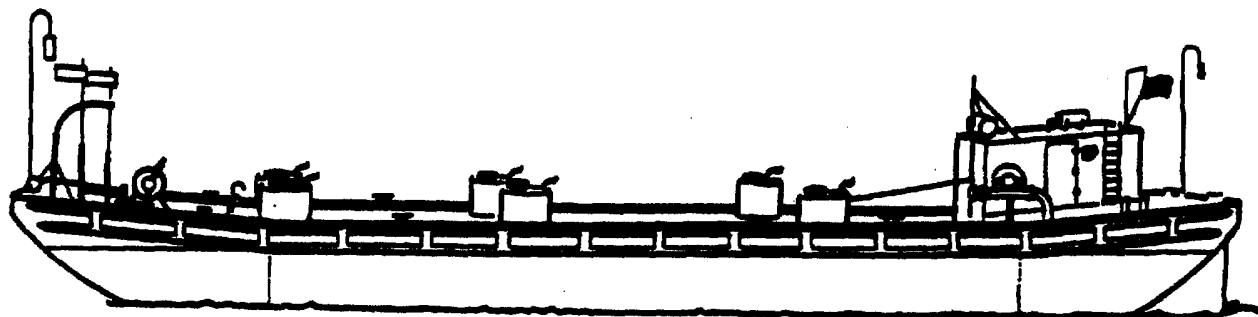

*Barge, Liquid Cargo, Non-propelled, Design 231C*

## CONVERSION KIT, BARGE, DECK ENCLOSURE

**PURPOSE:** To convert the 110 ft. and 120 ft. steel deck cargo barge, design 231A into covered barges to protect cargo.

**TRANSPORTABILITY:** Can be shipped in a knocked-down condition.

### ADMINISTRATIVE INFORMATION

DESIGNATION - BCDK

NSN - 1930-01-263-0143 231A with deck enclosure

NSN - 1935-00-392-2985 231A conversion kit, deck enclosure

LIN - B31197

COST - \$471,282 (June 1993)

TYPE CLASSIFICATION - STD-A

SPECIFICATION NO. - MIL-C-13766 (TC)

### PRINCIPAL CHARACTERISTICS

This demountable deckhouse kit consists of 35 sections or panels with coamings, bolts, nuts, gaskets, and miscellaneous parts. The sections form a watertight transverse bulkhead forward and to watertight longitudinal side bulkheads. The deckhouse top contains one large central hatch and four small hatches, one near each corner. Each side bulkhead contains two sliding doors. There is one watertight door in the forward bulkhead and a double sliding door in the aft bulkhead.

### HULL AND ACCOMMODATIONS DATA:

Construction - Steel.

Length, - 92 ft. (28 meters)

Width - 27ft.(8.2m)

Height, centerline of deckhouse - 13 ft. (3.9 m)

Weight - 60.5 short tons (54.9 0)

Capacity:

Covered deck area - 2,300 ft.<sup>2</sup>; 27,000 ft.<sup>3</sup> (213.9 m<sup>2</sup>; 756 m<sup>3</sup>)

Cargo hatches - (5):

Hatch openings:

One 16 ft. by 20 ft.(4.8 m by 6.1 m)

Four 9 ft. 5-7/8 in. by 6 ft. 8-3/4 in. (2.8 m by 2 m)

Cargo doors - (5):

Door openings -10 ft. by 9.5 ft. (3 m by 2.9 m)

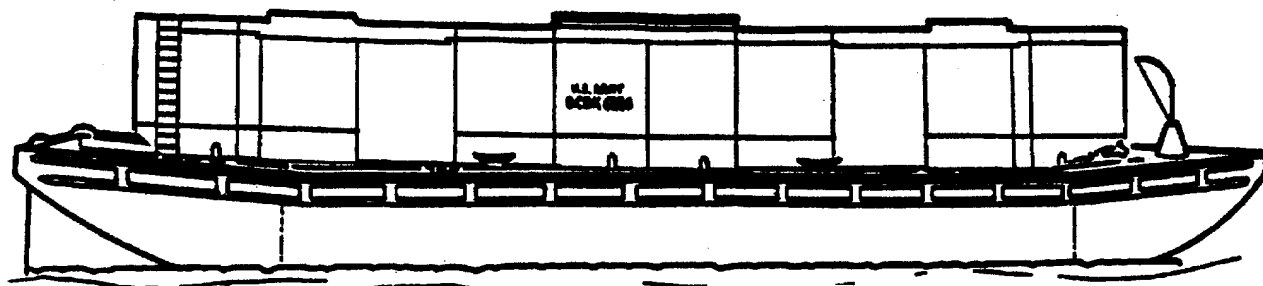

*Conversion Kit, Barge, Deck Enclosure*

**CRANE, BARGE, 60 - TON, DESIGN 413D**

PURPOSE: To load and discharge heavy-ft cargo that is beyond the capacity of ship's gear.  
TRANSPORTABILITY: Can be towed to overseas destinations.

**ADMINISTRATION INFORMATION**

DESIGNATION - BD  
NSN - 1935-00-264-6220  
LIN - F35953  
COST - \$708,845 (June 1993)  
TYPE CLASSIFICATION - STD-A  
SPECIFICATION NO. - MIL -C-10309

**PRINCIPAL CHARACTERISTICS****HULL AND ACCOMMODATIONS DATA:**

Construction - Steel.

Length, overall - 142 ft. (43.3 meters)

Beam, molded - 58 t. (17.6 m)

Depth, molded - 12 (3.6 m)

Displacement:

Light - 1132 long tons (1150 t.)

Draft without lift:

Mean - 3 ft. 5 in. (1 m)

Draft with ballast and load:

Mean - 5 ft. 1 in. (1.5 m)

Freeboard without lift:

Mean - 8ft 7 in. (.6 m)

Capacity:

Fuel - 1,350 gal. (5073 L)

Lube oil - 60 gal. (227 L)

Fresh water - 600 gal. (2271 L)

Anchors:

Number - 3

Type:

One 750 lb (340 kg) steel "Danforth"

Two 500 lb (227 kg) steel "Danforth"

Anchor Cables:

Number - 2

Type:

One 58.33 fathoms (106.7 m); 1-1/4 in. (31.8 mm) steel

One 50 fathoms (91.4 m); 7/8 in. (22.2 mm) steel

Cargo handling equipment:

Crane:

Boom length - 82 ft. 6 in. (25 m)

Main block:

Capacity - 60 long tons -1-0 t)73-foot (22.2 m)radius

Speed - 22-1/2 ft (6.8 m) per min

Auxiliary:

Capacity - 15 long tons (15.2 t) @ 100-foot (30.5 m) radius

Speed - 60 ft (18.3 m) per min.

Operating rage - 360 degrees

Rotating speed - 0.4 rpm'

Hoist:

Drive - gear

Number of drums - 3

Size of drums - 23-5/8 i. by 4 ft. 3in. (60 cm by 1.3 m)

Drum line pull:

Main hoist - 134,00 lb (61,017 kg)

Boom luffing - 134,00 lb (61,17 kg)

Auxiliary hoist - 33,600 lb (15,254 kg)

Clutch operation - air

Brake operation - mechanical and magnetic

Wire rope:

Type - improved plow steel

Main block - 6 ft. x 19 ft. (1.83 m x 5.79 m), 1-1/8 in. (28.6 mm) dial 1,330 ft. (405.6 m)

Auxiliary - 6 ft. x 19 t. (1.83 m x 5.79 m), 7/8 in. (22.23 mm) dia., 730 ft. (222.6 m)

Luffing hoist - 6 ft. x 19 ft. (1.83 m x 5.79 m), 1-1/8 in. (28.6 mm) dia., 1,400 ft. (427 m)

Generators:

Main;

Crane service:

Number - 1

Current - dc

Output - 150 kw

Voltage - varies according to hull number

240

120/240

Engine:

Number - 1

Type - diesel

Horsepower - varies according to hull number

257 hp @ 600 rpm

240 hp @ 600 rpm

Auxiliary:

Vessel service:

- Number - 1
- Current - dc
- Output - varies according to hull number
  - (a) 5 kw
  - (b) 10 kw
  - (c) 25 kw
- Voltage - varies according to hull number
  - (a) 240
  - (b) 120/240
  - (c) 120/240

Engine:

- Number - 1
- Type - diesel
- Horsepower - varies according to hull number
  - (a) 10 hp @ 1200 rpm
  - (b) 16 hp @ 1200 rpm
  - (c) 20 hp @ 1200 rpm
  - (d) 42 hp @ 1200 rpm

Safety equipment:

Fire-fighting equipment:

- One 50 lb (22.7 kg) CO<sub>2</sub> cylinders
- Eight 15 lb (6.8 kg) CO<sub>2</sub> cylinders
- One 2-1/2 gal. (9.5 L) foam extinguisher
- Six 2-3/4 lb (1.2 kg) monobromotrifluoromethane charge hand extinguisher or equivalent

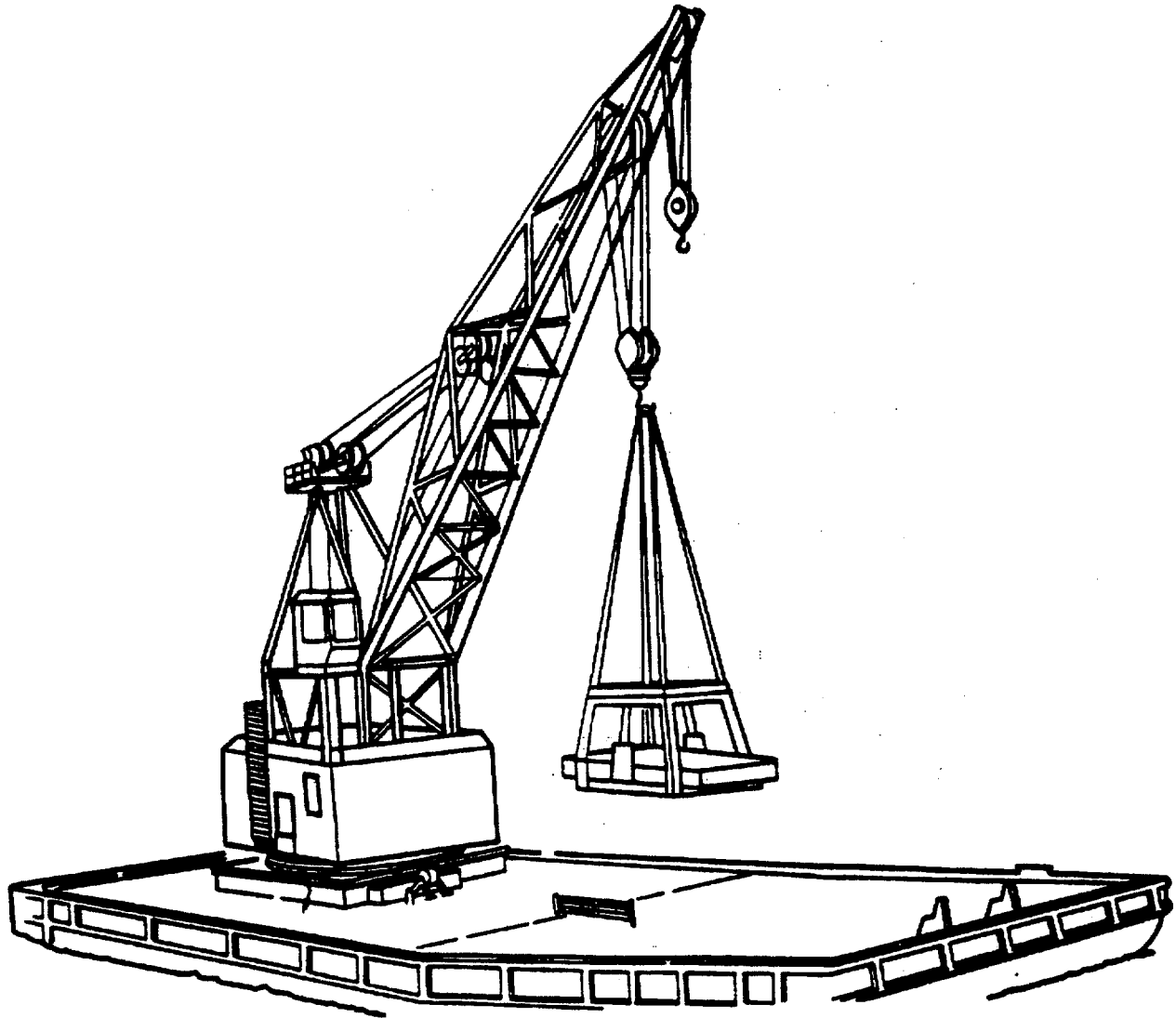

*Crane, Barge, 60-Ton, Design 413D*

**CRANE, BARGE, 100 - TON, DESIGN 264B**

PURPOSE: To load and discharge heavy-lift cargo that is beyond the capacity of ship's gear.  
TRANSPORTABILITY: Can be towed to overseas destinations.

**ADMINISTRATION INFORMATION**

DESIGNATION - BD  
NSN - 1935-00-264-6219  
LIN - F36090  
COST - \$8,000,104 (June 1993)  
TYPE CLASSIFICATION - STD-A  
SPECIFICATION NO. - MIL-C-10776

**PRINCIPAL CHARACTERISTICS****HULL AND ACCOMMODATIONS DATA:**

Construction - Steel  
Length, overall- 140 ft. (42.7 metres)  
Beam, molded - 70 ft. (21.3 m)  
Depth, molded - 12 ft. 6 in. (3.8 m)  
Displacement, full load - 1,630 long tons 1656 t)  
Draft, full load:  
Mean - 6 ft. 3-1/4 in. (1.9 m)  
Freeboard, full load:  
Mean - 6 ft. 2-3/4 in. (1.9 m)  
Capacity:  
Fuel - 15,000.gal. (56,775 L)  
Lube oil- 110 gal. (416L)  
Fresh water - 200 gal. (757 L)  
Anchors:  
Number- 2  
Type- 4,200 lb (1907 kg) stockless  
One 750 lb (340 kg) steel "Danforth"  
Two 500 lb (227 kg) steel "Danforth"  
Anchor Chains:  
Number - 2  
Type - 30 fathoms (54.9m), 1-1/2 in. (38.1 mm)  
Cargo handling equipment:

Crane:

Boom length - 123 ft. 6 in. (7.6 m)

Main block:

Capacity - 89 long tons (90.4 t) @ 80 ft. (24.4 m) radius

Capacity - 75 long tons (76.2 t) @ 104 ft 6 in. (31.8 m) radius

Speed - 14 ft (4.2 m) per min.

Auxiliary:

Capacity - 15 long tons (15.2 t) @ 122 ft. 6 in. (37.3 m) radius

Speed - 79 ft (24.1 m) per min.

Reach below waterline - 25 ft. (7.6 m)

Operating range - 360 degrees

Rotating speed - 0.333 rpm

Hoist:

Drive - gear

Number of drums - 4

Size of drums:

Main (2) - 51 in. by 98-7/8 in. (1.3 m by 2.4 m)

Boom luffing (1) - 75 in. by 90-7/8 in. (1.9 m by 2.2 m)

Auxiliary (1) - 36 in. by 89-1/4 in. (92 cm by 2.2 m)

Drumline pull:

Main hoist - 16,150 lb each (7,332 kg)

Boom luffing - 49,000 lb (2,246 kg) for two ropes

Auxiliary hoist - 9,065 lb (4115.5 kg)

Wire rope:

Type - improved plow steel

Main block - 6 f. x 37 ft. (1.8 m x 11.2 m), 1-1/8 in. (28.6 mm) dia., 2,30 ft. (771.6 m)

Boom luffing (2) - 6 ft. x 30 ft. (1.8 m x 9.1 m), 1-1 in. (31.8 mm) dia., 1,050 ft. (320 m)

Auxiliary - 6 ft. x 37 ft. (1.8 m x 11.2 m), 7/8 in. (22.2 mm) dia., 1,100 ft. (320 m)

Generators:

Main:

Crane service:

Number - 2

Current - dc

Output - 125 kw

Voltage - 240

Engine:

Number - 2

Type - diesel

Horsepower - 200 bhp @ 514 rpm each



Generators: (Continued)

Auxiliary:

Vessel service:

Number - 2

Current - 3 phase ac

Output - 50 kva

Voltage- 120/208

Engine:

Number - 2

Type - diesel

Horsepower - 70 bhp @ 1,200 rpm

Safety equipment:

Fire-fighting equipment:

One 525 lb (238 kg) fixed CO<sub>2</sub> system consisting of seven 75 lb (34 kg) CO<sub>2</sub> cylinders

Four 15 lb (6.8 kg) CO<sub>2</sub> extinguishers

One 2-1/2 gal. (9.5 L) foam extinguisher

Six 2-3/4 lb (1.2 kg) monobromotrifluoromethane charge hand extinguisher or equivalent

One soda-acid

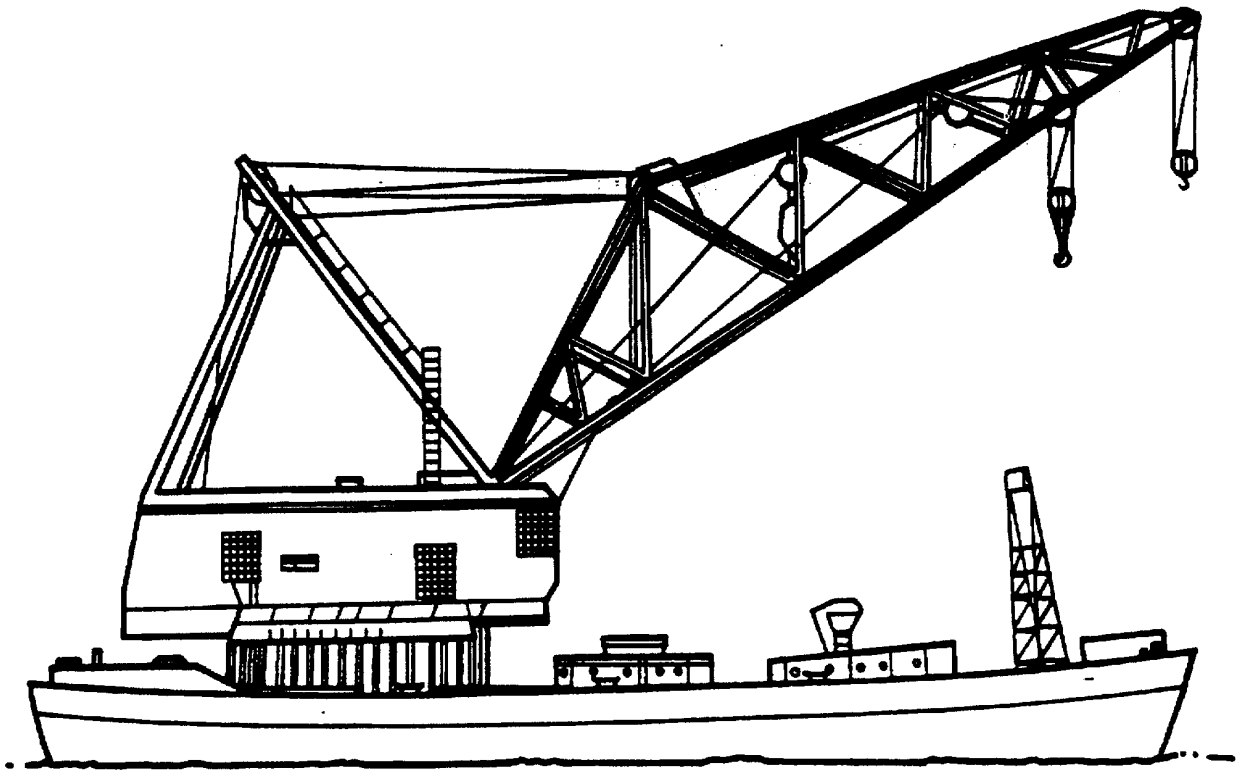

*Crane, Barge, 100-Ton, Design 264B*

**BARGE, DECK CARGO, NON-PROPELLED, SECTIONALIZED,  
NESTING, DESIGN 7001**

PURPOSE: To transport wheel and tracked vehicles and general cargo in harbors and other inland waters.  
TRANSPORTABILITY: Can be sectionalized, and nested for shipment by rail or marine transportation.

**ADMINISTRATION INFORMATION**

DESIGNATION - BK  
NSN - 1930-00-375-2967  
LIN - B31060  
COST - \$24,230 (May 1992)  
TYPE CLASSIFICATION - STD-A  
SPECIFICATION NO. - MIL-B-3596A

**PRINCIPAL CHARACTERISTICS**

**HULL AND ACCOMMODATIONS DATA:**

Construction - This steel barge consists of eight coupled transverse sections giving the following dimensions:

Length, overall- 81 ft. (24.7 meters)

Beam: Barge is tender because of its narrow beam, especially at the bottom. molded -

Top - 22 ft. (6.7 m)

Bottom - 17 ft. (5.2 m)

Depth, molded - 7 ft. (2 m)

Displacement:

Light- 51.3 long tons (52.1 t)

Loaded - 181.3 long tons (184.2 t)

Draft:

Light:

Forward- 1 ft. 6 in. (45.7 cm)

Mean - 1 ft. 6 in. (45.7 cm)

Aft - 1 ft. 6 in. (45.7 cm)

Loaded:

Forward - 4 ft. 9 in. (114.3 cm)

Mean - 4 ft 9 in. (1143 cm)

Aft-4 ft. 9 in. (114.3 cm)

Freeboard, mean:

Light - 5 ft. 6 in. (1.6 m)

Loaded - 2 ft. 3 in. (68.5 cm)

Capacity:

Deck area - 1,782 ft.<sup>2</sup> (165.7 m<sup>2</sup>)

Cargo:

Deck - 180 long tons (182.9 t)

Shipping: the eight barge sections, when nested, form the following groups:

Group 1 - Three pontoons nested - 10 ft. 6 in. x 7 ft. x 22 ft. (3.2 m x 2 m x 6.7 m)

Group 2 - Three pontoons nested - 10 ft. 6 in. x 7 ft. x 22 ft. (3.2 m x 2 m x 6.7 m)

Group 3 - Two rake-end pontoons nested - 10 ft. 6 in. x 7 ft. x 22 ft. (3.2 m x 2 m x 6.7 m)

Group 4 - deck frames - 10 6 in. x 4 ft. x 21 ft. (3.2 m x 1.2 m x 6.4 m)

Total - 7,820 ft<sup>3</sup> (221.4 m<sup>3</sup>)

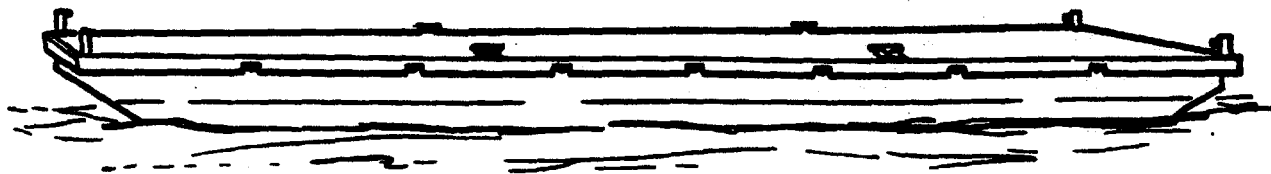

*Barge, Deck Cargo, Sectionalized, Nesting, Design 7001*

**BARGE, DECK CARGO, NON-PROPELLED,  
HARBORS AND INLAND WATERWAYS, DESIGN 7005**

PURPOSE: To transport wheel and tracked vehicles and general cargo in harbors and inland waters.

TRANSPORTABILITY: Can be towed to overseas destinations.

**ADMINISTRATION INFORMATION**

DESIGNATION - BC

NSN - 1930-00-375-2961

LIN - B30786

COST - \$58,778 (May 1992)

TYPE CLASSIFICATION - STD-A

SPECIFICATION NO. - MIL-B-10586

**PRINCIPAL CHARACTERISTICS**

**HULL AND ACCOMMODATIONS DATA:**

Construction - Steel. This barge is particularly suited for transporting vehicles due to its flush deck without fore and aft sheer. It is built without skegs, making it easy to operate at port terminals where piers are in close proximity to one another.

Length, overall- 110 ft (33.5 meters)

Beam, molded - 32 ft. (9.7 m)

Depth, molded - 9 ft. (2.7 m)

**Displacement:**

Light - 120 long tons (121.9 t)

Loaded - 690 long tons (701 t)

**Draft:**

**Light:**

Forward - 1 ft. 8 in. (50.8 cm)

Mean - 1 ft. 8 in. (50.8 cm)

Aft - 1 ft 8 in. (50.8 cm)

**Loaded:**

Forward - 7 ft. 4 in. (2.2 m)

Mean - 7 ft. 6 in. (2.2 m)

Aft - 7 ft. 8 in. (2.3 m)

**Freeboard, mean:**

Light - 7 ft. 4 in. (2.2 m)

Loaded - 1 ft. 6 in. (45.7 cm)

Capacity, Cargo, Deck - 570 long tons (579.1 t)

**Anchors:**

Number - 2

Type - 300 b (136.2 kg) "Danforth"

**Anchor Cables:**

Number - 2

Type - 50 fathoms (91.44 m); 7/8 in. (22.2 mm) steel



*Barge, Deck Cargo, Non-propelled, Harbors and Inland Waterways, Design 7005*

PIER, BARGE TYPE, SELF-ELEVATING, NON-PROPELLED, STEEL,  
300 ft. Long, 80 ft. Wide, (91.5 m Long, 24.4 m Wide) DESIGN 7029

PURPOSE: To provide either a temporary or a semipermanent pier at locations where shore-side facilities are nonexistent.

TRANSPORTABILITY: Can be towed to overseas destinations.

ADMINISTRATIVE INFORMATION

DESIGNATION - BPL

NSN - 1945-00-999-7899

LIN - N90785

COST - \$813,810 (June 1993)

TYPE CLASSIFICATION - STD-A

SPECIFICATION NO. - MIL-B-10586

PRINCIPAL CHARACTERISTICS

HULL AND ELEVATING MECHANISM DATA:

Construction - Steel.

Length, overall - 300 ft. (91.5 meters)

Beam, molded - 80 ft. (24.4 m)

Depth, molded - 13 ft. (3.9 m)

Caissons:

Number - 10

Length - 60 ft. vice 140 ft. (183.3 m vice 42.7 m)

Diameter - 5 ft. 11 in. (1.8 m) outside diameter

Air jack, Pneumatic, Type "D" (Not interchangeable with type "A")

Number - 10

Height - 10 ft. 6 in. (3.2 m)

Width - 9 ft. 7-1/2 in. (2.9 m)

Accessory Equipment:

Air Compressors:

Number - 2

Type - Reciprocating, 2 stage

Type of drive - diesel engine

Capacity (each) - 350 psi, 425 ft.<sup>3</sup> per minute (24.6 kg/cm<sup>2</sup>, 11.9 m<sup>3</sup>/min.)

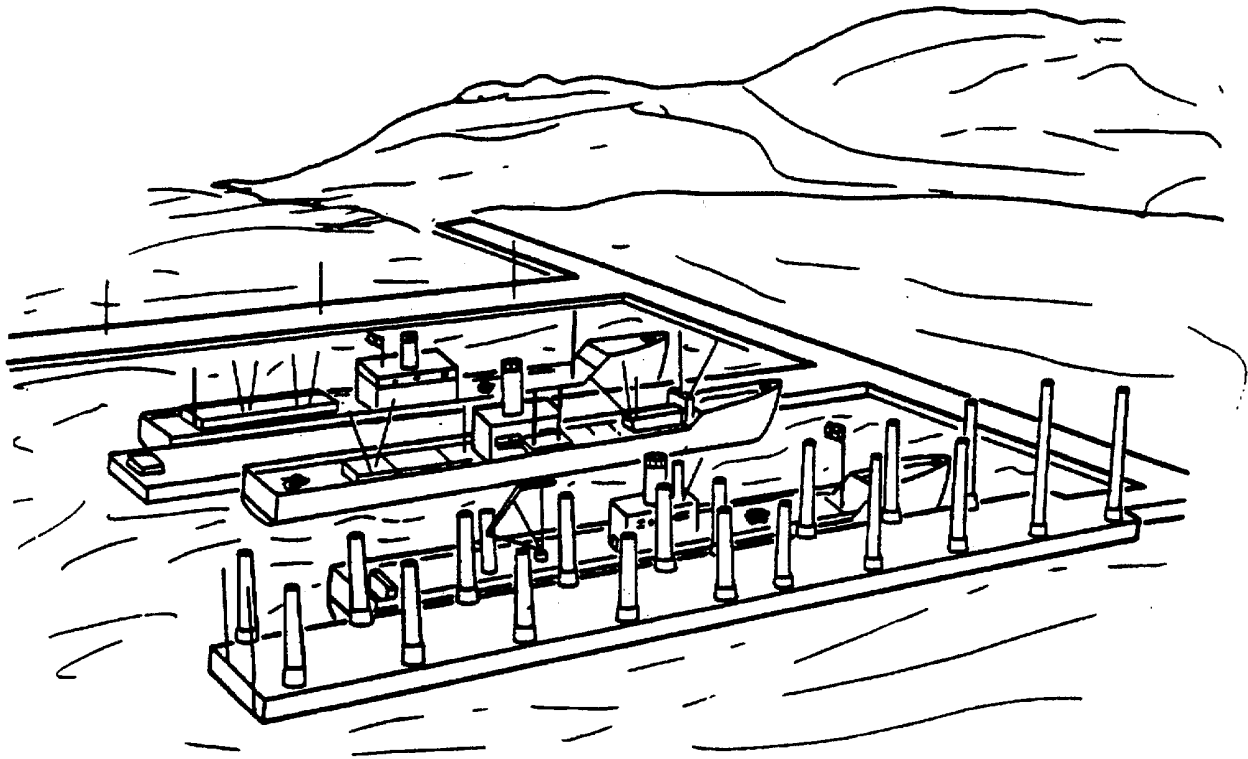

Pier, Barge Type, Self-Elevating, Non-propelled, Steel, 300 ft. Long, Design 7029



## BARGE, WATER PURIFICATION, NON-PROPELLED

PURPOSE: To provide drinking water, converted from sea water or brackish water for a rapid deployment force in a forward area.

TRANSPORTABILITY: Vessel is not suitable for ocean towing. It should be deck loaded on a larger vessel for transportation to an overseas destination.

## ADMINISTRATION INFORMANON

DESIGNATION - ROWPU

NSN - 1930-01-234-2165

COST - \$5,262,715 (May 1992)

## PRINCIPAL CHARACTERISTICS

## HULL AND ACCOMMODAIONS DATA:

Construction - A design 231 barge with steel frame equipment house containing two complete 150,000 GPD reverse osmosis water purification units (ROWPU). Below deck are drinking water storage tanks, a chlorination unit, auxiliary generators, and spare ROWPU engines.

Length, overall- 120 ft. (36.6 meters)

Beam, molded - 33 ft. (10 m)

Depth, molded - 10.5 ft. (3.2 m)

## Displacement:

Light - 420 tons (463 t)

Loaded - 505 tons (513 t)

## Generators (primary) - 1

Current - ac

Output - 155 kw

Voltage - 440 Vac

## Engine, generator (primary) - 2

Type - diesel turbo charged, 6-cylinder

Horsepower - 300 hp @ 1200 rpm

## Generators (auxiliary) - 1

Current - ac

Output - 20 kw

Voltage - 440 Vac

## Engine, generator (auxiliary) - 2

Type - diesel, 4-cylinder

Horsepower - 72 h @ 2500 rpm

## Tank capacities -

Drinking water tanks (4)	15,000 gallons (56,775 L) total
Water reserve tank	250 gallons (946 L)
Fuel oil tanks (2)	7,200 gallons (27,252 L) total
Fuel oil day tank	320 gallons (1,211 L)
Sludge tank	250 gallons (946 L)
Ballast tank	10,000 gallons (37,850 L) - Fwd void # 1

## Life saving equipment:

- Eight-person liferaft (2)
- Lifesaving ring (4)
- Life Vest (24)

## Fire Fighting Equipment:

- Halon 1301 system
- CO<sub>2</sub> hose/reel units (2)
- Smoke detector system
- CO<sub>2</sub> extinguishers, 15 lbs (17)
- Dry chemical extinguisher 10 lbs (5)

## Dayroom:

- Berthing, 9 person

## Winch, shore:

- Type - Double drum
- Capacity - 40,000 lbs
- Engine - 4 cylinder
- Horsepower - 152 hp @ 2100 rpm

Anchors - Four 1000 lbs

Anchor winch, electrical

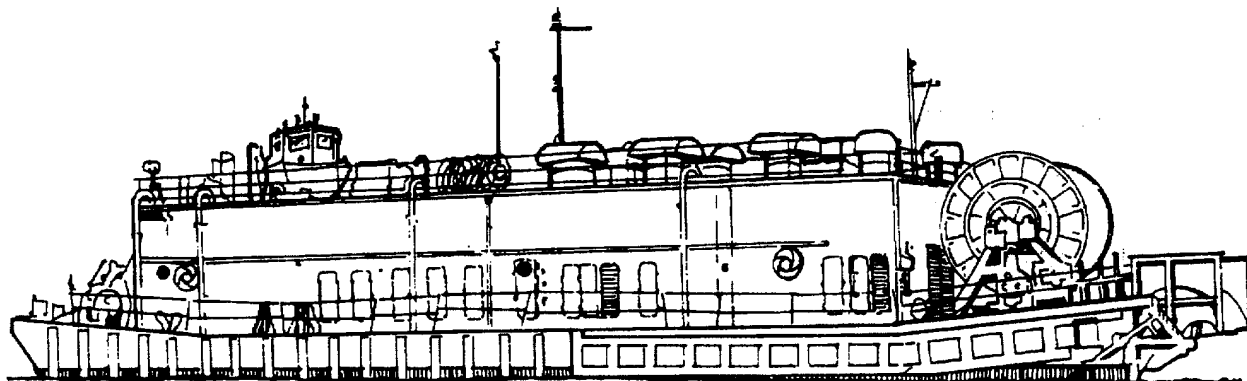

Barge, Water Purification, Non-propelled

WORKBOAT, LIFESAVING AND FIREFIGHTING

PURPOSE: To transport light cargo and troops ship to shore, ship to ship and utility work.

TRANSPORTABILITY: The workboat is carried as deck cargo on board the 300 thousand gallon Reverse Osmosis Water Purification Unit (ROWPU) Barge.

ADMINISTRATIVE INFORMATION

DESIGNATION - Workboat, Lifesaving and Firefighting

NSN - 1940-01-303-5752

LIN -

COST - \$30,374 (June 1993)

PRINCIPAL CHARACTERISTICS

MOBILITY AND ENGINE DATA:

Speed - 30 knots (48 km/hr)

Cruising range - 70 nautical miles (113 km)

Main propulsion engine:

Number - 1

Type - 6 cylinder turbocharged diesel

Horsepower - 55 hp @3600 rpm

Fuel consumption - 16.6 gal. (63 L) per hour

Propeller - Stainless steel, 3-blade 19-in. pitch, 16-in. diameter, right hand rotation

Hull and Accommodations Data:

Construction - Aluminum

Overall length - 26 ft.

Overall width -

Overall height -

Weight -

Displacement - 2700 lbs

Draft- 1.3 ft.

Capacity:

Fuel - 50 gal. (189 L)

Passengers - 5-6

Crew - 1-2

Anchor:

Number - 1

Type - S

Anchor line:

Depth - 396 fathoms (75 ft.)

Firefighting equipment:

Halon, automatic, 70 ft.<sup>3</sup> (1.96 m<sup>3</sup>)

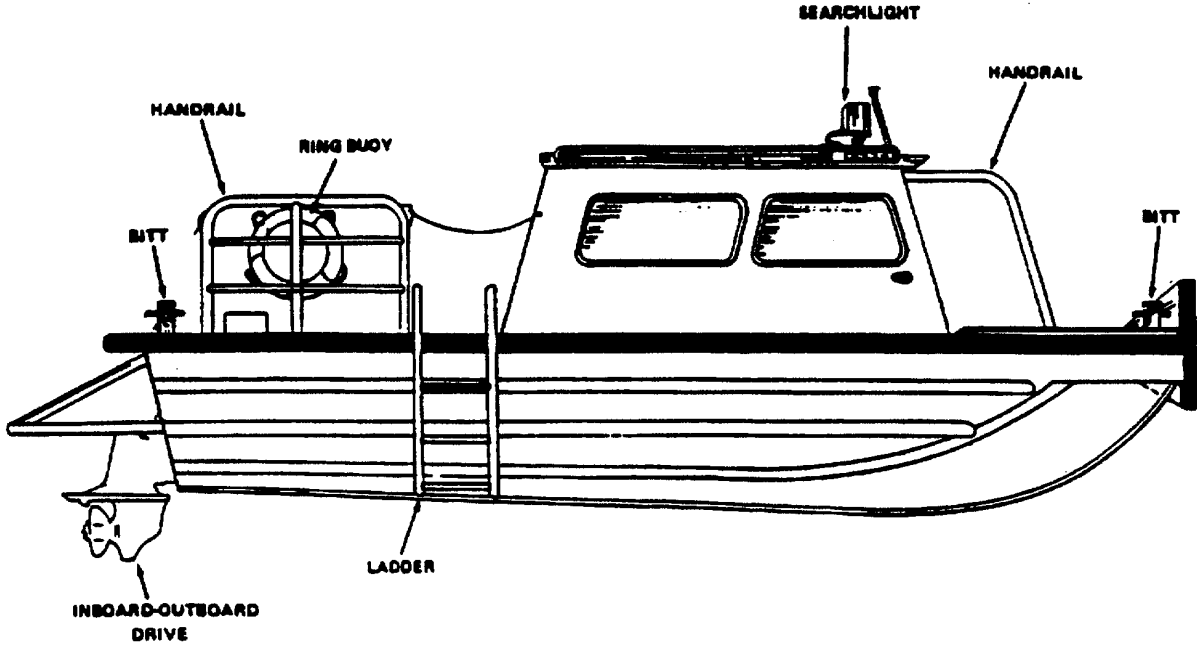

Workboat, Lifesaving and Firefighting

## BRIDGE ERECTION BOAT

PURPOSE: Transportable, hydrojet propelled, aluminum hull boat designed to maneuver components of floating bridges. This boat can also be used to propel rafts, support diving operations, assist in maritime construction projects, serve as a troop and cargo carrier, and patrol inland waters.

TRANSPORTABILITY: Cradled and truck mounted.

## ADMINISTRATIVE INFORMATION

DESIGNATION - BEB

NSN- 1940-01-105-5728

LIN - B25476

COST - \$154,530 (June 1993)

## PRINCIPAL CHARACTERISTICS

## MOBILITY AND ENGINE DATA:

Speed - 22 mph (40 km/hr)

Cruising range - 154 miles (248 km)

Main propulsion engine:

Number - 2

Type - 6 cylinder turbocharged diesel

Horsepower - 215 hp @2500 rpm (each)

Fuel consumption - 10.8 gal. (40.9 L) per hour @ 2400 rpm

Propelling unit:

Description - hydrojet

Hull and Accommodations Data:

Construction - Aluminum

Overall length - 27 ft. 2in. (8.3 m)

Displacement - 8800 lbs (4000 kg)

Draft - 2 ft. 2 in. (66 cm)

Capacity:

Fuel - 75 gal. (284 L)

Passengers - 12

Crew - 3

Anchor:

Number - 1

Type - 24 lb "Danforth"

Anchor line:

Depth - 100 ft.

Firefighting equipment:

Two Halon, automatic, 70 ft.<sup>3</sup> (1.96 m<sup>3</sup>)

One 5 lb. (2.3 kg) CO<sub>2</sub>

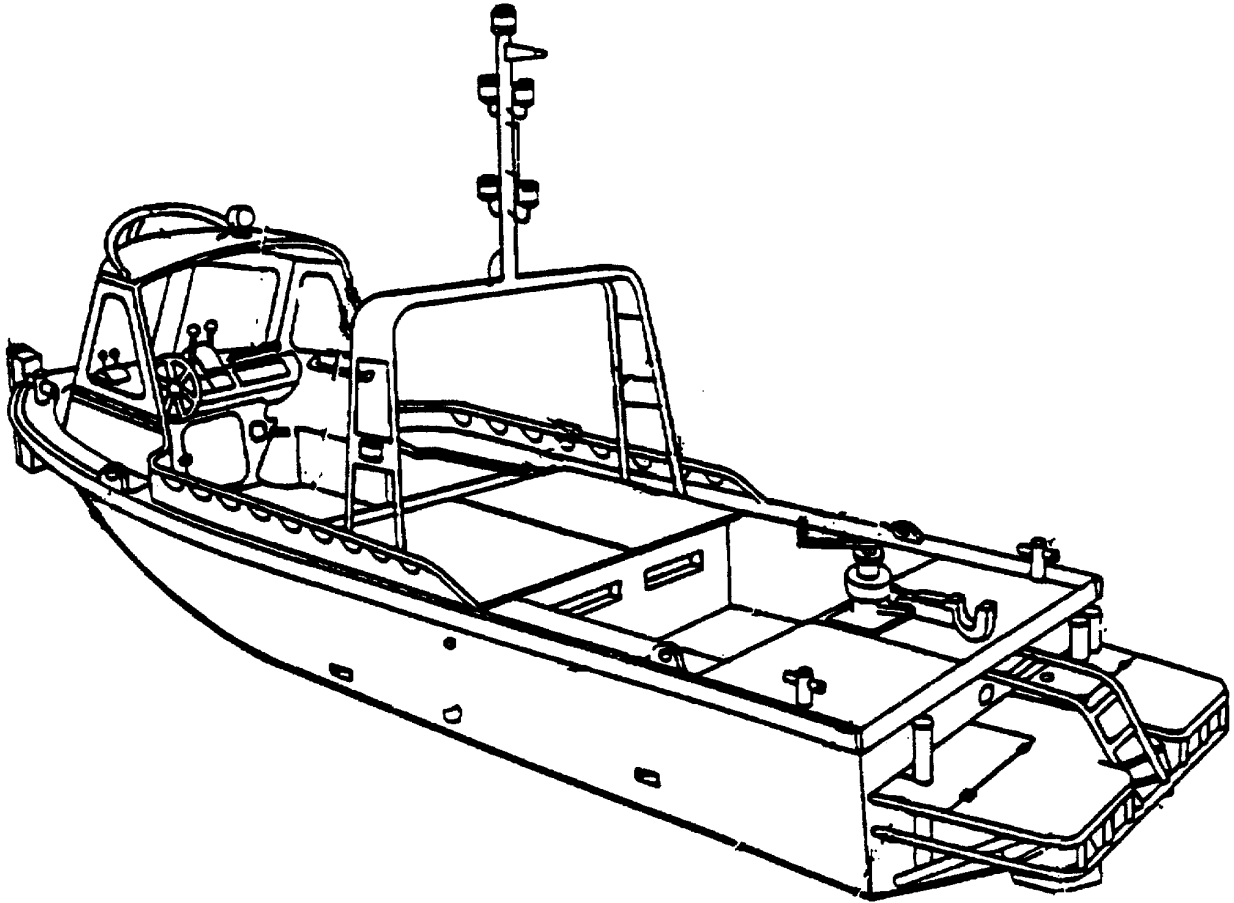

Bridge Erection Boat

## BOAT, PICKET, DESIGN 4002

PURPOSE: To serve as a patrol or command and inspection boat in harbors and inland waters.

TRANSPORTABILITY: Can be deck loaded on a larger vessel for transportation to overseas destination.

## ADMINISTRATIVE INFORMATION

DESIGNATION - Q

NSN - 1940-00-268-9955

LIN - B84267

COST - \$142,482 (June 1993)

CTA 50-942

Type classification - STD-A

Specification No. - MIL-B-11790

## PRINCIPAL CHARACTERISTICS

## MOBILITY AND ENGINE DATA:

Speed - 14 knots (26 km/hr)

Cruising range - 468 nautical miles (867 km)

Man propulsion engines:

Number - 2

Type - diesel

Horsepower - 200 bhp @ 1600 rpm (each)

Fuel consumption - 24.2 gal. (91.6 L) pr hour

Propellers:

Number - 2

Description - bronze, 3-blade, 25 in. (63.5 cm) pitch, 34 in. (86.4 cm) diameter

Generator, vessel service:

Number - 1

Current - dc

Output - 10 kw

Voltage - varies according to hull number

120

Engine:

Number - 1

Type - diesel

Horsepower - Two designs which vary according to hull number:

25 hp @ 1450 rpm

18.8 hp @ 1450 rpm

Hull and Accommodations Data:

Construction - Wood

Overall length - 64 ft. 11 in. (19.8 m)

Beam, molded - 15 ft. 11 in. (4.8 m)

Beam, extreme - 16 ft. 5-1/2 in. (5 m)

Depth, molded - 8 ft. 3 in. (2.5 m)

Displacement:

Light - 31 long tons (31.5 t)

Loaded - 37.4 long tons (38 t)

Draft:

Light:

Forward - 3 ft. 11 in. (1.2 m)

Mean - 4 ft. 4 in. (1.3 m)

Aft - 4 ft. 9 in. (1.4 m)

Loaded:

Forward - 3 ft. 10 in. (1.1 m)

Mean - 4 ft. 10 in. (1.5 m)

Aft-5 ft. 10 in. (1.8 m)

Freeboard:

Light- 3 . 11 in. (1.2 m)

Loaded - 3 ft. 5 in. (1 m)

Capacity:

Fuel - 900 gal. (3,407 L)

Fresh water - 400 gal. (1514 L)

Cargo - 4 long tons (4.1 t)

Passengers - 5

Crew - 6

Anchors:

Number - 2

Type:

One 100 lb (45.4 kg) stockless

One 75 lb (34 kg) stockless

Anchor line:

Number - 2

Type - 40 fathoms (73.2 m), 5 in. (12.7 cm) manila

Safety Equipment:

Firefighting equipment:

Two 50 lb (22.7 kg) fixed CO<sub>2</sub> systems

Five 15 lb (6.8 kg) CO<sub>2</sub> extinguishers

Two 2-3/4 lb (1.2 kg) monobromotrifluoromethane extinguishers

Lifeboat

Number - 1

Type - 110-person, balsa

Boat:

Number - 1

Type - 10-foot dinghy



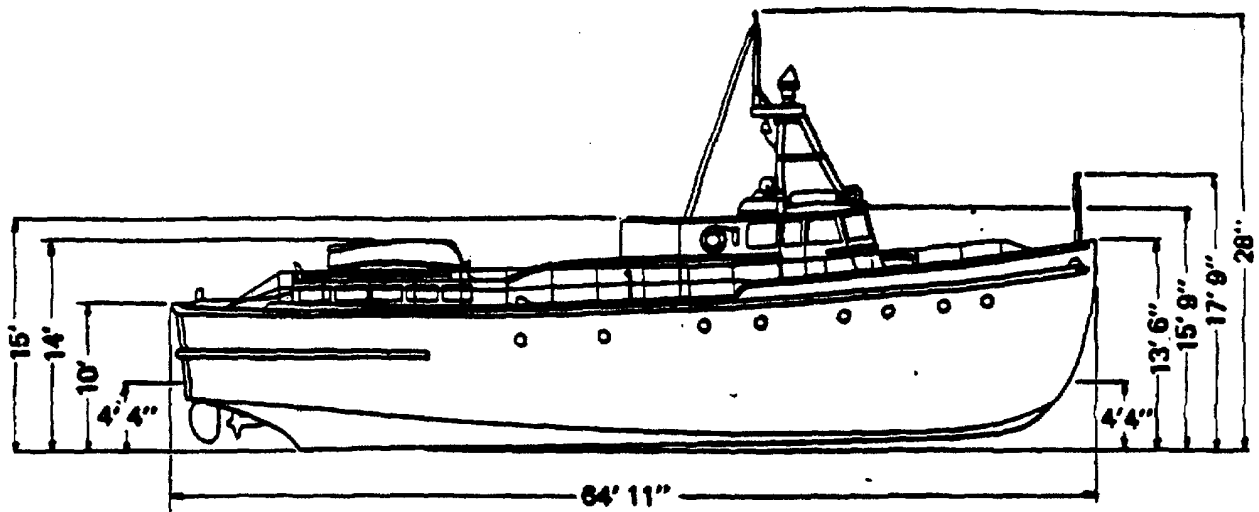

Boat, Picket, Design 4002

## BOAT, PICKET, DESIGN 4003

PURPOSE: To serve as a patrol or command and inspection boat in harbors and inland waters.

TRANSPORTABILITY: Can be deck loaded on a larger vessel for transportation to overseas destination.

## ADMINISTRATIVE INFORMATION

DESIGNATION - J

NSN - 1940-00-267-1099

LIN - B84130

COST - \$40,951 (May 1992)

Type classification - STD-A

Specification No. - MIL-B-11746

## PRINCIPAL CHARACTERISTICS

## MOBILITY AND ENGINE DATA:

Speed:

Light- 15 knots (27.8 km/hr)

Loaded - 14 knots (25.9 k. m/hr)

Cruising range:

Light - 266 nautical miles (492.6 km)

Loaded - 200 nautical miles (370.4 km)

Main propulsion engines:

Number - 2

Type - diesel

Horsepower - 165 bhp @ 1800 rpm (each)

Fuel consumption - 19 gal. (72 L) per hour

Propellers:

Number - 2

Description - bronze, 3-blade, 28-in (1 cm) pitch, 28-in. (71.1 cm) diameter

Generator, vessel service:

Number - 1

Current - dc

Output - 2.5 kw

Voltage - 24 to 30

Engine:

Number - 1

Type - diesel

Horsepower - 5.5 hp @ 1800 rpm

Hull and Accommodations Data:

Construction - Steel

Overall length - 46 ft. 4-1/2 in. (14.1 m)

Beam, amidships, molded - 12 ft. 3 in. (3.7 m)

Depth, amidships, molded - 6 ft. 3-7/8 in. (1.9 m)

## Displacement:

Light - 10 long tons (10.2 t)

Loaded - 12 long tons (12.2 t)

## Draft:

## Light:

Forward - 1 ft 2 in. (36 cm)

Mean - 1 ft. 7-1/2 in. (49 cm)

Aft - 2 ft. 1 in. (76 cm)

## Loaded:

Forward - 1 ft. 4 in. (40.6 cm)

Mean - 2ft. 1in. (76.3 cm.)

Aft - 2 ft. 9 in. (83.8 c)

## Freeboard, mean:

Light - 4 ft. 8-3/8 in. (1.4 m)

Loaded - 4ft. 3-3/8 in. (1.3 m)

## Capacity:

Fuel - 370 gal. (1,400 L)

Potable water - 50 gal. (169 L)

Passengers - 3

Crew - 4

## Anchor:

Number - 1

Type - 50 lb (22.7 kg) "Danforth"

## Anchor line:

Number - 1

Type - 15 fathoms (27.4 m), 3-3/4 in. (9.5 cm) manila

## Safety Equipment:

## Firefighting equipment:

Two 15 lb (6.8 kg) fixed CO<sub>2</sub> systems

Two 2-3/4 lb (1.2 kg) monobromotrifluomethane extinguishers

## Lifeboat:

Number - 1

Type - Lifeboat, Inflatable, 7-person

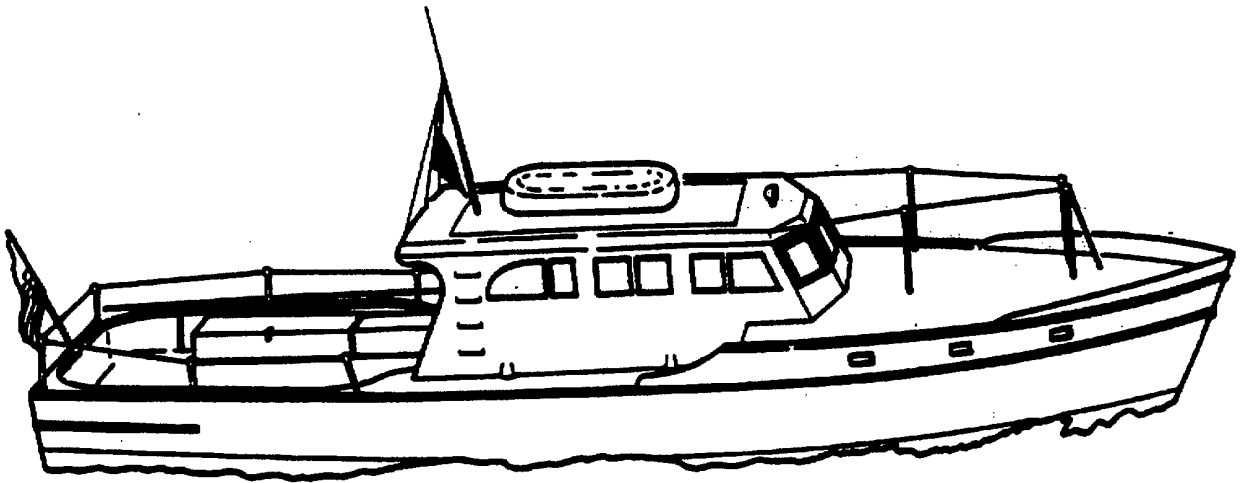

Boat, Picket, Design 403

BOAT, PICKET

PURPOSE: To serve as a patrol or command and inspection boat in harbors and inland waters.

TRANSPORTABILITY: Can be deck loaded on a larger vessel for transportation to overseas destination.

ADMINISTRATIVE INFORMATION

DESIGNATION - J

NSN - 1940-01-300-5306

LIN - B84927

COST - \$94,760 (June 1993)

PRINCIPAL CHARACTERISTICS

MOBILITY AND ENGINE DATA:

Speed:

Light - 25 knots (km/hr)

Loaded - 18 knot (m/hr)

Cruising range - 46 hours

Main propulsion engine:

Number - 1

Type - Diesel, turbo

Horsepower - 200 hp

Fuel consumption- 3 g. (11.4 L) per hour

Propellers:

Number - 1

Hull and Accommodations Data:

Construction - Composite - foam core

Overall length - 26 ft. 6 in. (8 m)

Beam, amidships, molded - 8 ft. 6 in. (2.6 m)

Capacity:

Fuel - 140 gal. (530 L)

Passenger- 15

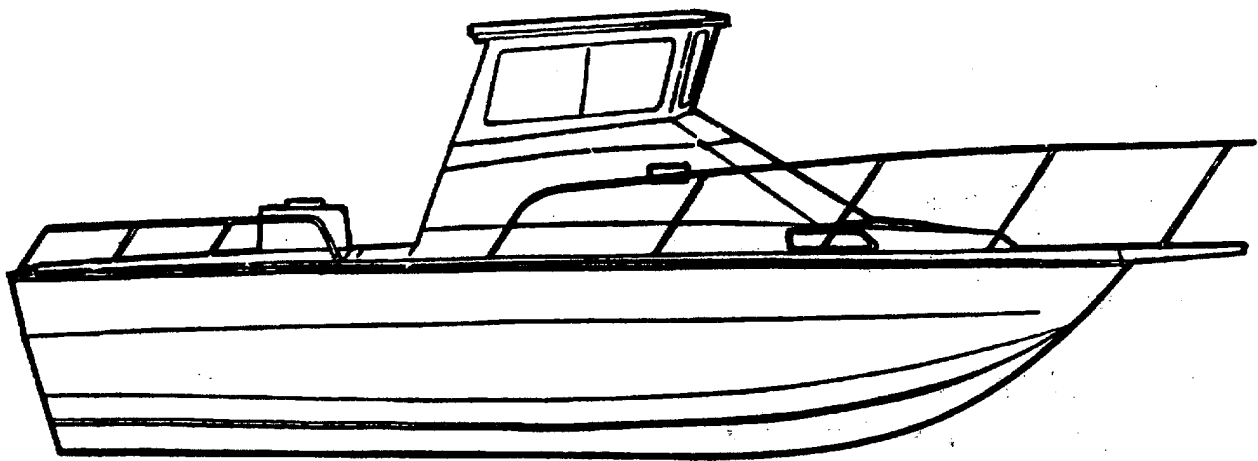

Boat, Picket

## BOAT, PASSENGER AND CARGO, DESIGN 2001

PURPOSE: To serve as a utility boat to transport passengers and cargo in harbors and inland waters.

TRANSPORTABILITY: Can be deck loaded on a larger vessel for transportation to overseas destination.

## ADMINISTRATIVE INFORMATION

DESIGNATION - T

NSN - 1940-00-268-9952

LIN - B83993

COST - \$134,647 (June 1993)

CTA 50-909

Type classification - STD-A

Specification No. - MH-B-10863A

## PRINCIPAL CHARACTERISTICS

## MOBILITY AND ENGINE DATA:

Speed:

Light - 10.5 knots (19.4 km/hr)

Loaded - 7 knots (13 km/hr)

Cruising range:

Light - 725 nautical miles (1342 km)

Loaded - 635 nautical miles (1176 km)

Main propulsion engine:

Number - 1

Type- diesel

Horsepower - 300 bhp 1200 rpm

Fuel consumption - 18.2 gal (68.8 L) per hour

Propeller:

Number - 1

Description - Manganese bronze, 3-blade, 32-in. (81.3 cm) pitch, 46-in. (1.2 m) diameter

Generator, vessel service:

Number- 1

Current - d

Output - 5 kw

Voltage- 120

Engine:

Number- 1

Type - diesel

Horsepower - 20 hp @ 1200 rpm

Hull and Accommodations Data:

Construction - Steel

Overall length - 65 ft. 6-3/4 in. (20 m)

Beam, molded - 17 ft. 8 in. (5.3 m)

Depth, molded - 8 ft. 9-7/8 in. (2.6 m)

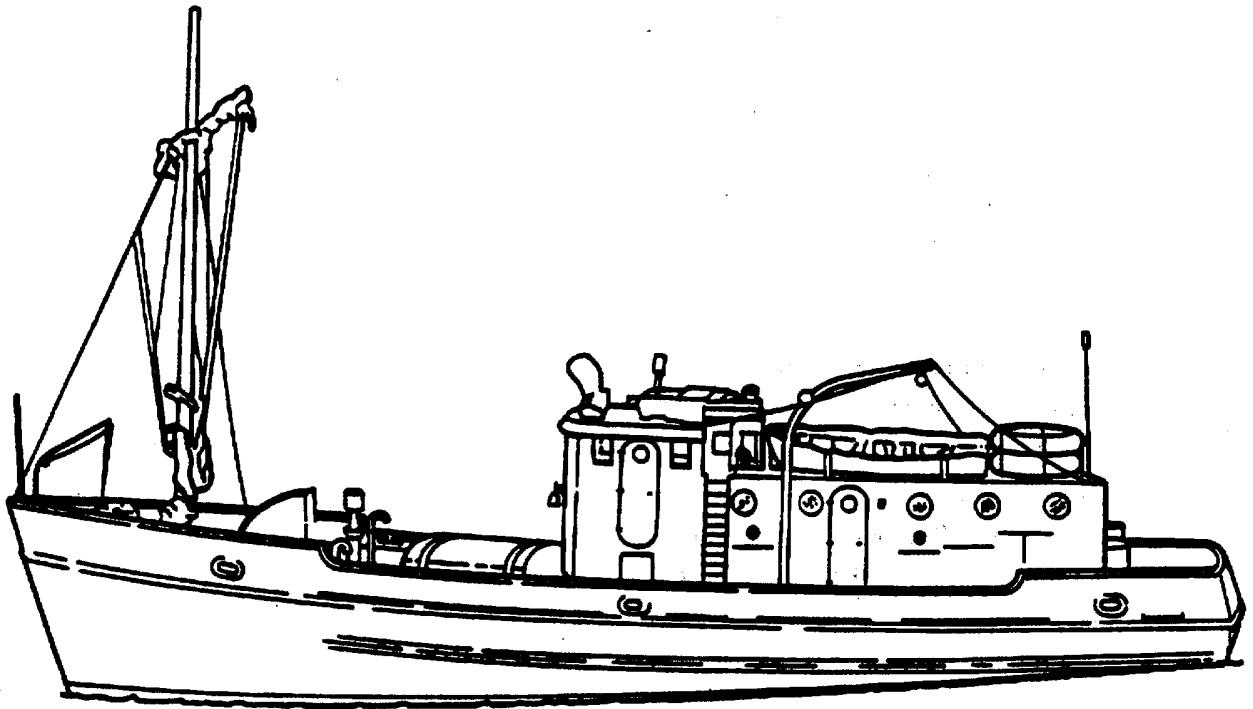

Boat, Passenger and Cargo, Design 2001



BOAT, 65 FT., PASSENGER, DESIGN 6013

PURPOSE: To transport passengers.

TRANSPORTABILITY: Can be deck loaded on a larger vessel for transportation to overseas destination.

ADMINISTRATIVE INFORMATION

DESIGNATION-

NSN - 1930-00-651-5686

LIN - H38924

COST - \$800,000 (June 1993)

CTA 50-909

PRINCIPAL CHARACTERISTICS

MOBILITY AND ENGINE DATA:

Speed:

Loaded - 11 knots (km/hr)

Cruising range:

Main propulsion engines:

Number - 2

Type- diesel

Horsepower - 165 bhp @ 1800 rpm

Propellers:

Number - 2

Hull and Accommodations Data:

Construction - Steel

Overall length - 65 f. 6 i. (20 m)

Beam, molded - 23 ft. (7 m)

Depth, molded - 7 ft. 3 in. (2.2 m)

Draft:

Loaded - 5 ft. (1.5 m)

Capacity:

Passengers - 150

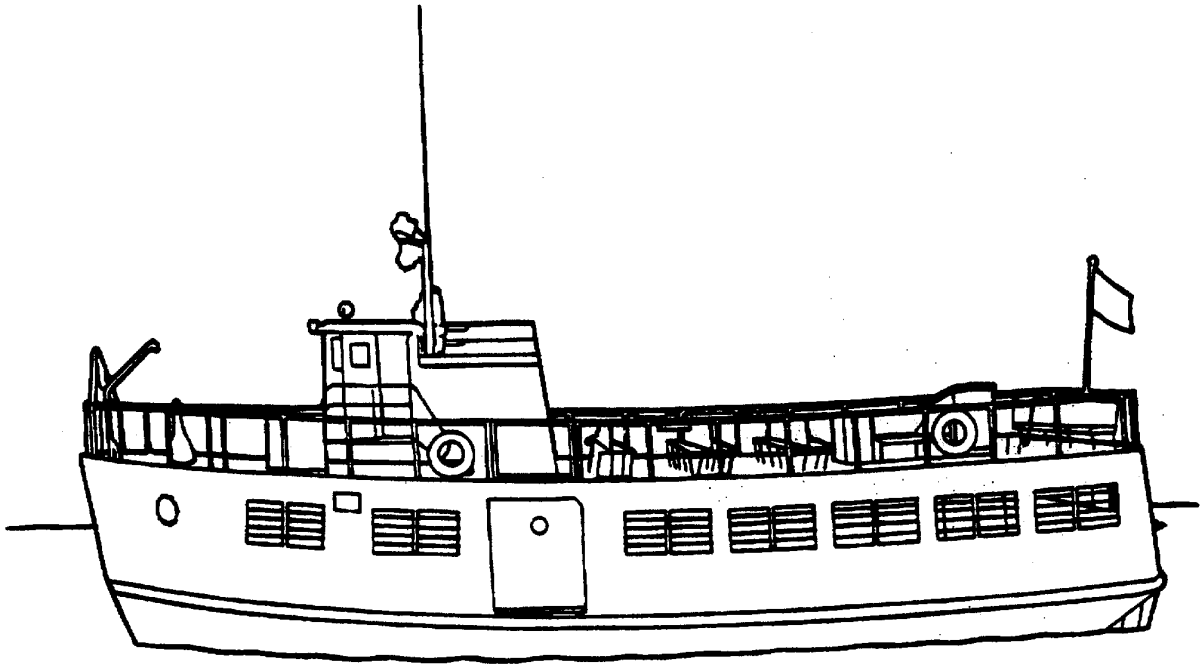

Boat, 65ft., Passenger, Design 6013

## HIGH SPEED FERRY PASSENGER

PURPOSE: To serve u a ferry boat to transport passengers in waters to sea sate 3.

TRANSPORTABILITY: Can be deck loaded on larger vessel for transportation overseas destination.

## ADMINISTRATIVE INFORMATION

DESIGNATION - HSPF

NSN - 1940-01-229-1264

COST - \$1,700,000 (June 1993)

## PRINCIPAL CHARACTERISTICS

## MOBILITY AND ENGINE DATA:

Speed:

Loaded - 25 knots (46 km/hr)

Cruising range - 200 nautical miles (371 km)

Passenger capacity - 236

Main propulsion engines:

Number - 2

Type - diesel

Horsepower - 990 hp each

Fuel capacity - 1,400 gallons (5,300 L)

Fuel consumption - 85 gallons (322 L) per hour

Propeller:

Number - 2

Description - Manganese bronze, 5 blade, 40 in. (1 m) diameter

Generator, vessel service:

Number - 2

Current - ac

Output - 5 kw

Voltage - 208

Engine:

Number - 2

Type - diesel

Hull and Accommodations Data:

Construction - Aluminum catamaran hull

Overall length - 75 ft. 6 . (75.5 m)

Beam, molded - 28 ft. 6 in. (8.7 m)

Depth, molded - 7 ft.3 in. (2.2 m)

Draft - 5 ft. 6 in. (1.7 m)

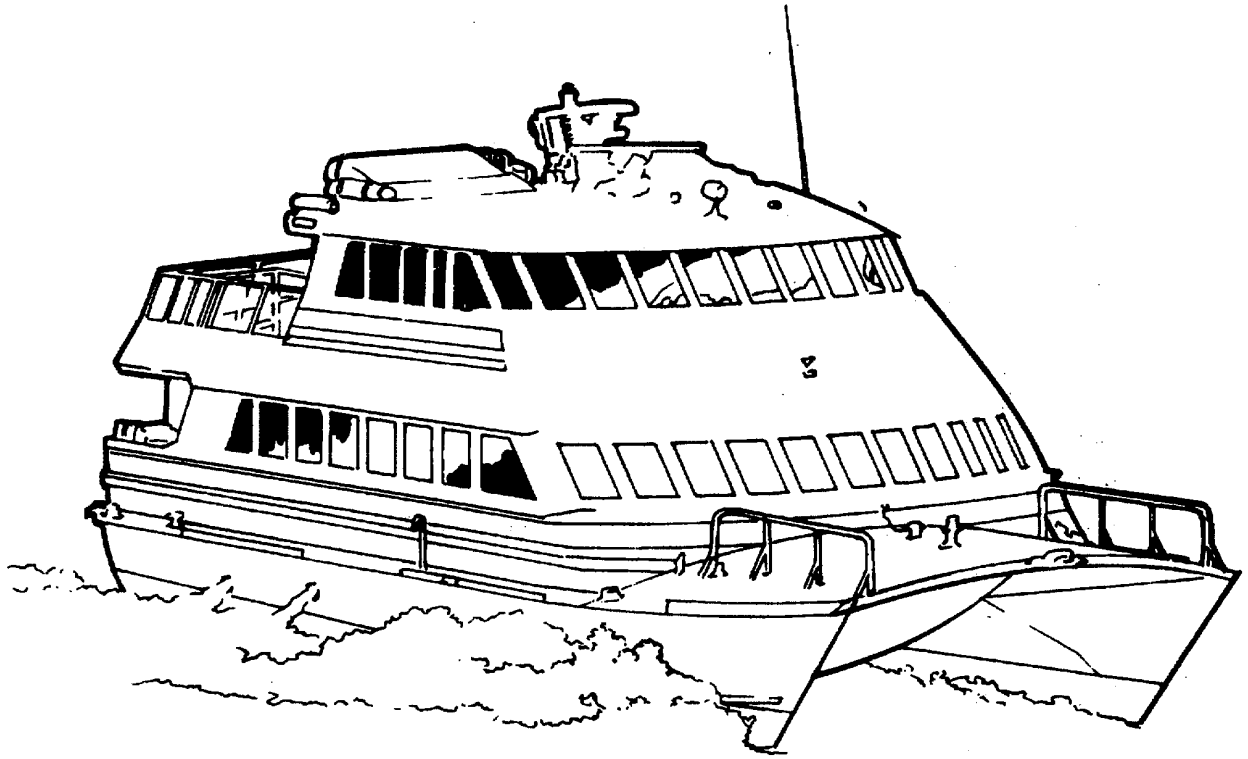

High Speed Ferry, Passenger

**REPAIR SHOP, FLOATING, MARINE EQUIPMENT,  
NON-PROPELLED, DESIGN 7011**

**PURPOSE:** To repair floating craft and amphibious equipment i harbors and inland waters. Due to the mission and function, these vessels were modified to suit mission they now accomplish.

**TRANSPORTABILITY:** Can be towed to overseas destinations.

**ADMINISTRATIVE INFORMATION**

DESIGNATION - FMS  
NSN - 1935-00-375-3000  
LIN - R76483  
TA - 55-56  
COST - \$608,785 (June 1993)  
TYPE CLASSIICATION - STD-A  
SPECIFICATION NO. - MIL-R-11798

**PRINCIPAL CHARACTERISTICS****HULL AND ACCOMMODATIONS DATA:**

Construction - Steel.

Length, overall- 210 ft. 5 in. (64.2 meters)

Beam, molded - 40 ft. (12.2 m)

Depth, molded - 15 ft. (4.6 m)

Displacement:

Light - 1,160 long tons (1,179 t.)

Loaded - 1,525 long tons (1,549 t.)

Draft:

Light:

Forward - 5 t 8 . (1.7 m)

Mean - 5 ft. 11 in. (1.8 m)

Aft- 6 ft 1 in. (1.9 m)

Loaded:

Forward - 7 t 5 . (2.3 m)

Mean - 7 ft. 7 in. (2.3 m)

Aft - 7 t 9 in. (2.4 m)

Freeboard, mean: -

Light - 9 ft. 1 in. (2.7 m)

Loaded - 7 ft. 5 in. (2.3 m)

Generators:

Number - 4

Current - ac

Output - 100 kw

Voltage - 230

Engines:

Number- 4  
 Type - diesel  
 Horsepower - 150 bhp @ 1,200 rpm

Fuel consumption- 34 gal. (129 L) per hour

Evaporator:

Number - 1  
 Type - Thermocompression  
 Capacity - 2,000 gal. (7570 L) per day

Capacity:

Fuel - 52,000 gal. (196,820 L)  
 Lube oil - 600 gal. (2271 L)  
 Potable water - 15,000 gal. (56,775 L)  
 Fresh water - 26,000 gal. (98,410 L)

Hatches:

Main deck house top (2):  
 Location - Frames 33 to 41  
 Size - 16 ft. (4.8 m) long by 8 ft. (2.4 m) wide  
 Location - Frames 68 to 74  
 Size - 12 ft. (3.6 m) long by 8 ft. (2.4 m) wide

Main deck (3):

Location - Frames 33 to 41  
 Size - 16 ft (4.8 m) long by 8 ft. (2.4 m) wide  
 Location - Frames 51 to 57  
 Size - 12 (3.6 m) long by 8 ft. (2.4 m) wide  
 Location - Frames 68 to 74  
 Size - 12 ft. (3.6 m) long by 8 ft. (2.4 m) wide

Crane:

Boom length - 40 ft (12.2 m)

Block:

Capacity - 8.9 long tons (9.0 t) @ 12- to 35-foot (3.6- to 10.6- m) radius

Speed:

Single line - 15,000 lb (6,810 kg) load - 100 ft. (30.5 m) per min.  
 Four parts - 20,000 lb (9,080 kg) load - 25 ft. (7.6 m) per min.

Operating range - 360 degrees

Rotating speed - 1.5 rpm

Monorail Trolley system:

Hoists (4) capacities:  
 Three - 3 short tons (2.7 t)  
 One - 5 short tons (4.5 t)

Repair shops:

- Battery
- Blacksmith
- Carpentry
- Electrical
- Engine
- Fuel injector
- Machine
- Paint
- Pipefitting
- Radar and radio
- Refrigeration
- Sheet metal
- Shipfitting
- Welding

Anchors:

Number - 5

Type:

- Two 4000 lb (1816 kg) bower, stockless
- One 4000 lb (1816 kg) pare, stockless
- One 15,00 lb (681 kg) stream, stockless
- One 750 lb (3.40 kg) kedge, stockless

Anchor Chains:

Number - 2

Type - 105 fathoms (192 m); 1-1/2 in. (3.8 cm) steel

Safety equipment:

Fire-fighting equipment:

- One 850 lb (386 kg) CO<sub>2</sub> system consisting of seventeen 50 lb (22.7 kg) CO<sub>2</sub> cylinders
- One 50 lb (22.7 k) CO<sub>2</sub> system consisting of one 50 0 (22.7 kg) CO<sub>2</sub> cylinder
- Forty 15 b (6.8 kg) CO<sub>2</sub> extinguishers

Lifeboats:

Number - 2

Type - 30-person, 24 ft. (7.3 m) aluminum

Lifeboats:

Number - 4

Type - Inflatable 15 person, NSN 1940-00-204-3894

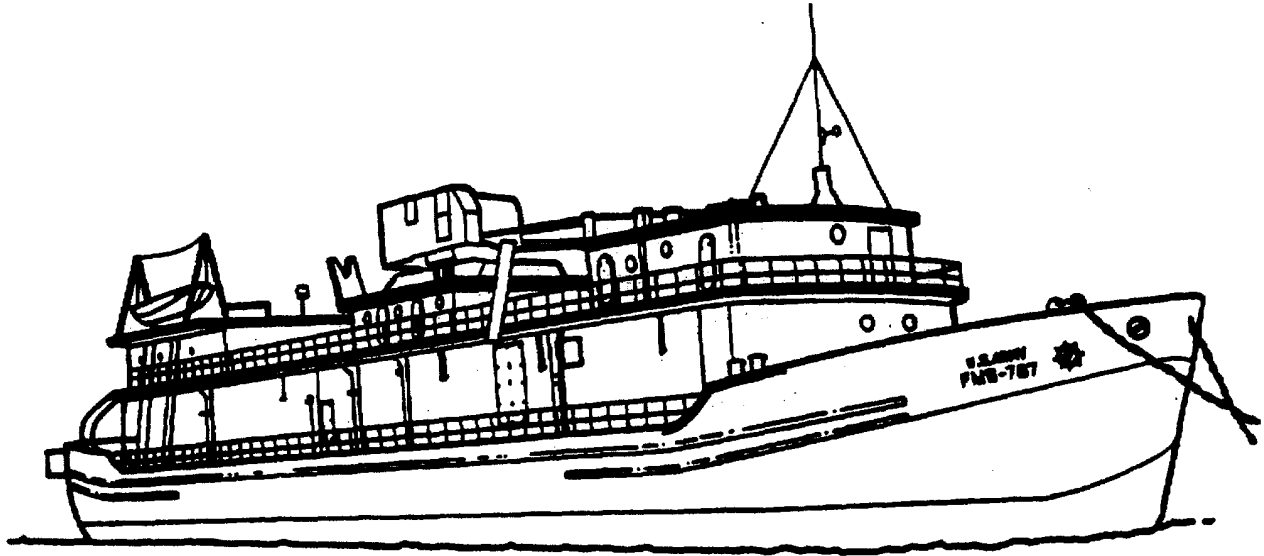

Repair Shop, Floating, Marine Equipment, Non-propelled, Design 7011



**TUG, 600 HORSEPOWER, 100 TON, DESIGN 3004**

**PURPOSE:** To move non-propelled barges in harbors and inland waters. Secondary functions include general utility uses, firefighting, salvage and assisting in the docking and undocking of barge vessels.

**TRANSPORTABILITY:** Can be deck loaded on a larger vessel for transportation to overseas destination.

**ADMINISTRATIVE INFORMATION**

DESIGNATION - ST

NSN - 1925-00267-1099

ULN - X70909

COST - \$316,988 (June 1993)

Type classification - STD-A

Specification No. - MIMT-10920B

**PRINCIPAL CHARACTERISTICS****MOBILITY AND ENGINE DATA:**

Speed:

Light - 12 knots (2.2 km/hr)

Loaded with tow - variable

Cruising range - Light - 1,700 nautical miles (3148 km)

Main propulsion engine:

Number - 1

Type- diesel

Horsepower - 600 bhp @ 750 rpm

Bollard pull - 17,500 lbs (7745 kg)

Fuel consumption - 36.4 gal. (138 L) per hour

Propeller:

Number- 1

Description - Manganese bronze, right hand rotation, 4-blade, 60 in. (1.5 m) pitch,  
72 in. (1.8 m) diameter

Generators, min vessel service:

Number - 2

Current - d

Output - Two designated ratings which vary according to generators installed

(a) 10 kw

(b) 20 kw

Voltage- 12w125

Engines:

Number - 2

Type - diesel

Horsepower - Three designated ratings which vary according engines installed

(a) 18.8 hp @ 1,450 rpm

(b) 25 hp @ 1,450 rpm

(c) 34 hp @ 1,200 rpm

## Hull and Accommodations Data:

## Construction - Steel

Overall length - 70 ft 11-1/2 in. (21.6 m)

Beam, molded - 19 ft 6 in. (5.9 m)

Depth, molded - 9 ft. 7-3/4 in. (2.8 m)

## Displacement:

Light - 100 long tons (102 t)

Loaded - 122 long tons (124 t)

## Draft:

## Light:

Forward - 6 ft 2 in. (1.8 m)

Mean - 6 ft 9 in. (2 m)

Aft - 7 ft 4 in. (2.2 m)

## Loaded:

Forward - 6 ft 8 in. (2 m)

Mean - 7 ft. 4-1/2 in. (2.2 m)

Aft - 8 ft 3 in. (2.5 m)

## Freeboard, mean:

Light - 2 ft. 11 in. (89 cm)

Loaded - 2 ft. 3 in. (69 cm)

## Capacity:

Fuel - 5,844 gal. (22,119 L)

Potable water - 900 gal. (3407 L)

Crew accommodations - 6

## Anchors:

Number - 2

## Type:

One 300 lb (136 kg) lightweight

One 200 lb (91 kg) lightweight

## Anchor chain:

Number - 1

Type - 75 fathoms (137 m), 5/8 in. (16 mm) wrought iron

## Safety Equipment:

## Firefighting equipment:

One 50 lb (22.7 kg) fixed CO<sub>2</sub> systemFour 15 lb (6.8 kg) CO<sub>2</sub> extinguishersTwo 5 lb (2.3 kg) C<sub>2</sub> extinguishers

One 2-1/2 gal. (9.5 L) soda-acid extinguisher

One fire pump, 500 gal per min. at 100 psi (189 l/min at 7 kg/cm<sup>2</sup>)

Lifeboat (1) - type - Inflatable, 15-person, NSN 1940-00-204-3894

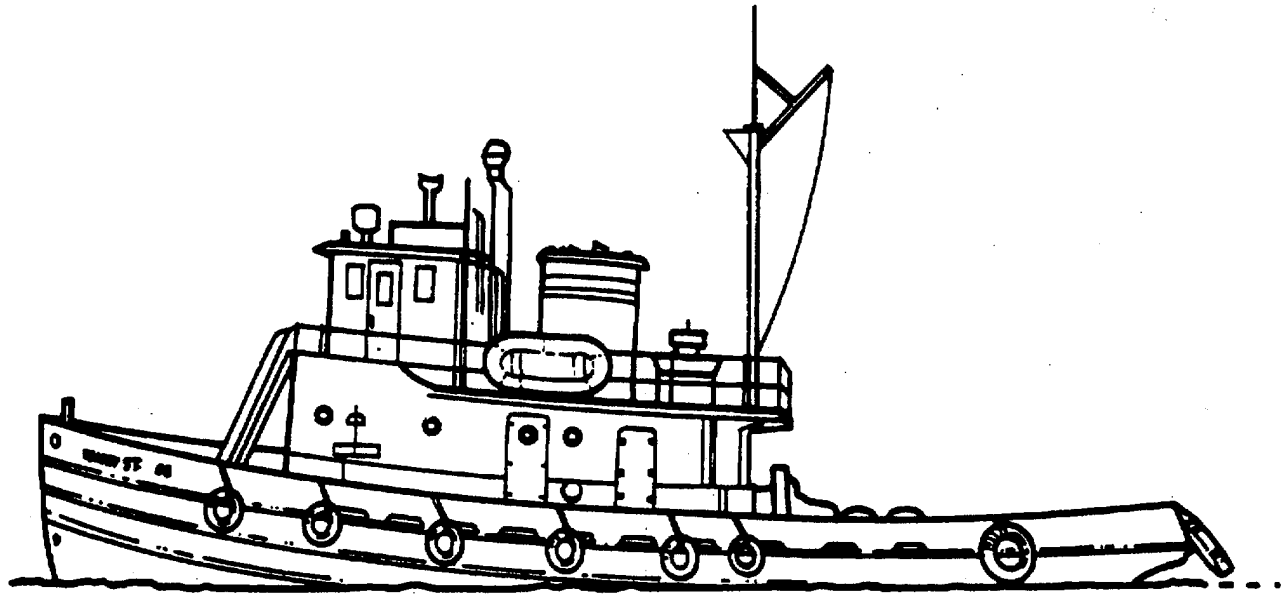

Tug, 600 hp, 100 Ton, Design 3004

3-59

**TUG, 1200 HORSEPOWER, DESIGN 3006**

**PURPOSE:** To berth and un-berth large vessels and for heavy towing within harbor areas. Secondary functions include general utility uses, fighting, and salvage operations. May perform limited offshore towing between terminals.

**TRANSPORTABILITY:** Capable of moving overseas destination under its own power.

**ADMINISTRATIVE INFORMATION**

DESIGNATION - LT  
 NSN - 1925-00-375-3003  
 LIN - X71046  
 COST - \$560,389 (May 1992)  
 Type classification - STD-A  
 Specification No. - MIL-T-10862A

**PRINCIPAL CHARACTERISTICS****MOBILITY AND ENGINE DATA:**

## Speed:

Light - 12.75 knots (23.6 k/hr)  
 Loaded with tow - variable

Cruising range - Light - 3,323 nautical miles (6154 km)

## Main propulsion engine:

Number - 1  
 Type- diesel  
 Horsepower - 1200 bhp 300 rpm

Bollard pull - 27,500 bs (12,485 kg)

Fuel consumption - 73 gal. (276 L) per hour

## Propeller:

Number- 1

Description - Two designs which vary according to hull numbers:

LT1936 through LT1977 and LT2202 - Manganese bronze, 3-blade, 2,060 s (935 kg),  
 7 ft. 8 in. (2.2 m) diameter, 62 in. (1.5 m) pitch  
 LT2075 through LT2096 - Manganese bronze, 3-blade, 2,485 lbs (1128 kg)  
 7 ft 8 in. (2.2 m) diameter, 54 in. (1.3 m) pitch

## Generators, main vessel service:

Number - 2  
 Current- dc  
 Output - 40 kw  
 Volage-120

## Engines:

Number - 2  
 Type of drive - diesel  
 Horsepower - Two designed ratings which vary according to engines installed  
 60 hp @ 1,200 rpm and 80 hp @ 1,200 rpm

## Hull and Accommodations Data:

## Construction - Steel

Overall length - 107 ft. (32.6 m)  
 Beam, molded - 26 ft. 6 i. (8 m)  
 Depth, molded - 14 ft 10 in. (4.5 m)

## Displacement:

Light - 295 long tons (300 0t)  
 Loaded - 390 long tons (396 t)

## Draft:

## Light:

Forward - 6 ft. 2 in. (1.8 m)  
 Mean - 8 ft. 10 in. (2.6m)  
 Aft - 11 ft. 6 in. (3.5 m)

## Loaded:

Forward - 9 ft 5 . (.8 m)  
 Mean - 10 ft. 9-1/2 in. (3.2 m)  
 Aft - 12 ft. 2 in. (3 7 :m)

## Freeboard, mean:

Light - 6 ft. (1.8 m)  
 Loaded - 4 ft. (1.2 m)

## Capacity:

Fuel - 21,46 g. (80,37 L)  
 Potable water - 2356 gal (10431 1)

## Seawater ballast:

Fore peak - 2,903  
 Aft peak - 5,493

Crew accommodations - 16

## Anchors 6):

## Type:

One 300 lb (136 kg) "Danforth"  
 One 800 lb (kg) marine fluked

## Anchor chains (2):

Type - 105 fathoms (192 m), 1 in. (25.4 mm) wrought iron and one 90 ft. (27.5 m)

## Safety Equipment:

## Firefighting equipment:

One 600 b (272 kg) fixed CO<sub>2</sub> system consisting of 12 50 lb (22.7 kg) cylinders  
 Four 15 lb (6.8 kg) CO<sub>2</sub> extinguishers  
 Two 5 lb (2.3 kg) CO<sub>2</sub> extinguishers  
 One fire pump, 300 gal. per pmi. at 100psi (1135 L/min at 7 kgcm<sup>2</sup>)

Lifeboats (2) - Type - Inflatable, 15-person, NSN 1940-00-204-3894

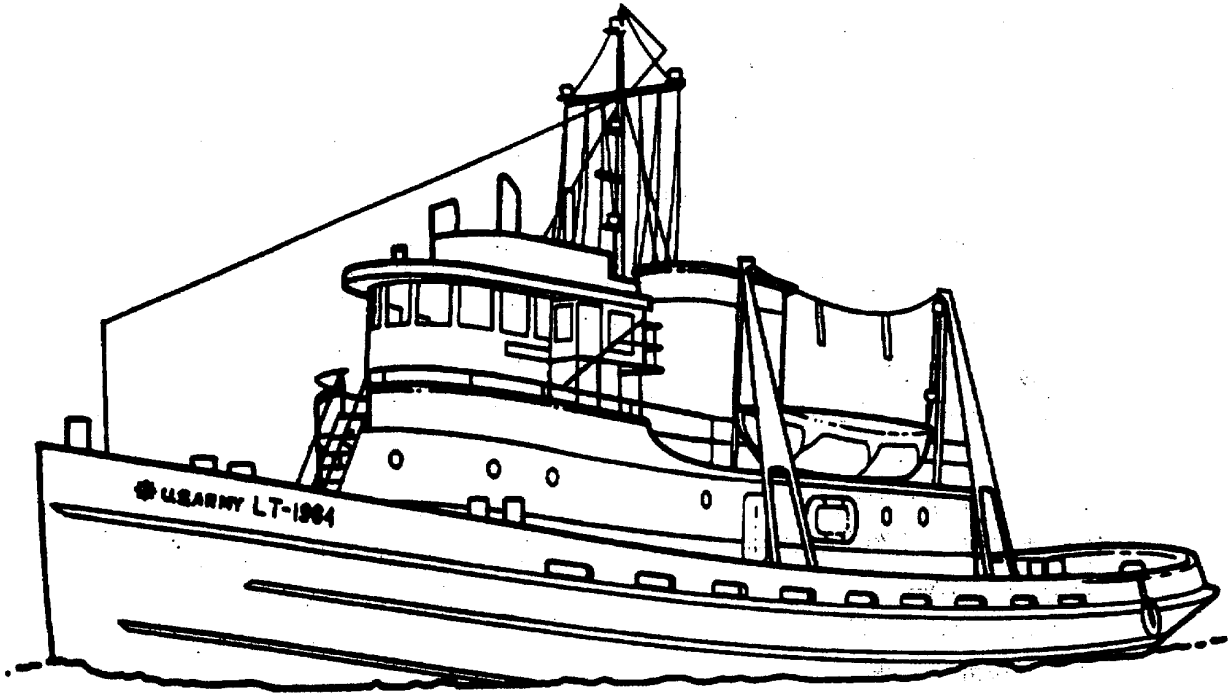

Tug, 1200 hp, Design 3006

**TUG, 200 HORSEPOWER, DESIGN 320**

**PURPOSE:** To move small non-propelled craft in harbors and inland waters. Other functions include general utility uses and firefighting.

**TRANSPORTABILITY:** Can be deck loaded on a larger vessel for transportation to overseas destination.

**ADMINISTRATIVE INFORMATION**

Designation - ST  
 NSN- 1925-00375-3001  
 LIN - X70772  
 COST - \$75,684 (June 1993)  
 CTA - 50-909  
 type classification - STD-A  
 Specification No. - MIL-T-10774A

**PRINCIPAL CHARACTERISTICS****MOBILITY AND ENGINE DATA:**

Speed:

Light - 10 knot (185 km/hr)

Loaded with tow- variable

Cruising range:

Light - 702 nautical miles (1300 km)

Loaded - Tow rope pull:

Speed (knots)	Pull (lbs)
0 (0 km/hr.)	5450 (2472 kg)
4 (7.4 km/hr.)	4500 (2041 kg)
5 (9.3 km/hr.)	4225 (1916 kg)
6 (11.1 km/hr.)	3800 (1724 kg)
7 (13 km/hr.)	3060 (1388 kg)

Main propulsion engine:

Number - 1

Type - diesel

Horsepower - 200 bhp @ 900 rpm

Fuel consumption - 10.25 gal. (38.8 L) per hour

Propeller:

Number - 1

Description - 44 in. (1.1 m) diameter, 36 i. (92 cm) pitch

Generator, min vessel service:

Number - 1

Current - dc

Output - 2 kw

Voltage- 120

## Engine:

Number - 1  
 Type of drive - diesel  
 Horsepower - 10 hp 1,200rpm

## Hull and Accommodations Data:

## Construction- Steel

Overall length - 45 ft. 2-1/4 in. (13.8 m)  
 Beam, molded - 12 ft. 9-3/4 in. (3.9 m)  
 Depth, molded - 7 ft 9-3/8 in. (2.3 m)

## Displacement:

Light - 25.2 long tons (25.6 t)  
 Loaded - 28.75 long tons (29.2 t)

## Draft:

## Light:

Forward - 3 ft. 6 in. (1 m)  
 Mean - 4 ft. 4 in. (1.3 m)  
 Aft - 5 ft. 1 in. (1.5 m)

## Loaded:

Forward - 4 ft. (1.2 m)  
 Mean - 5 ft. (1.5 m)  
 Aft - 6 ft. 2 in. (1.8 m)

## Freeboard, mean:

Light - 3 ft 6 in. (1 m)  
 Loaded - 2 ft. 10 in. (86 cm)

## Capacity:

Fuel - 800 gal. C3028 L)  
 Lube oil - 110 gal. (416 L)  
 Potable water - 50 gal. (189 L)  
 Crew accommodations - space for 4 berths

## Anchor (1):

Type - 85 lb (38.6 kg) "Danforth" Mark II

## Anchor chain (1):

Type - 25 fathoms (45.7 m), 3/8 in. (9.5 mm ) BBB (cit9ed ink)

## Safety Equipment:

## Firefighting equipment:

One 75 lb (34 kg) CO2 cylinder  
 Three 15 lb (6.8 kg) CO2 extinguishers  
 One 5 b (2.3 kg) C2 extinguishers  
 One 2-1/2 gal. (9.5 L) soda-acid extinguisher  
 One fire pump, 50 gal. p min. at 100 psi (189 la min at 7 kgcm2)

Lifeboat (1) - Type - 5-person, balsa



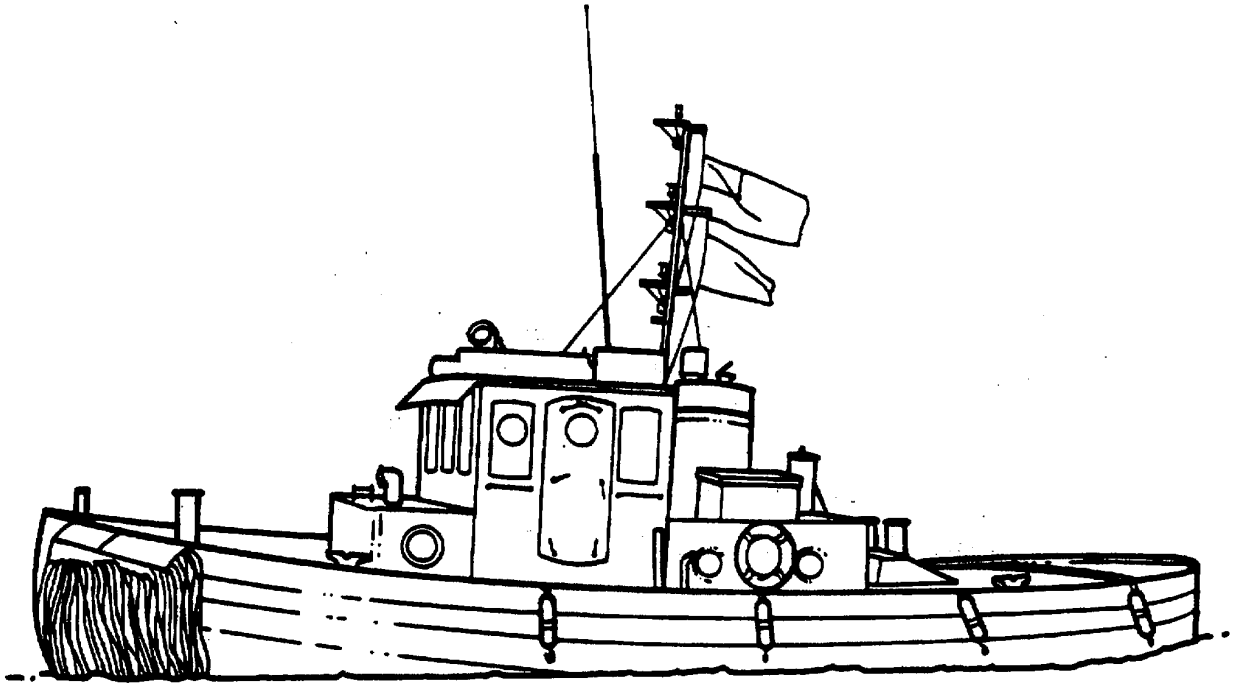

Tug, 200 hp, Design 320 (Sheet 1 of 2)

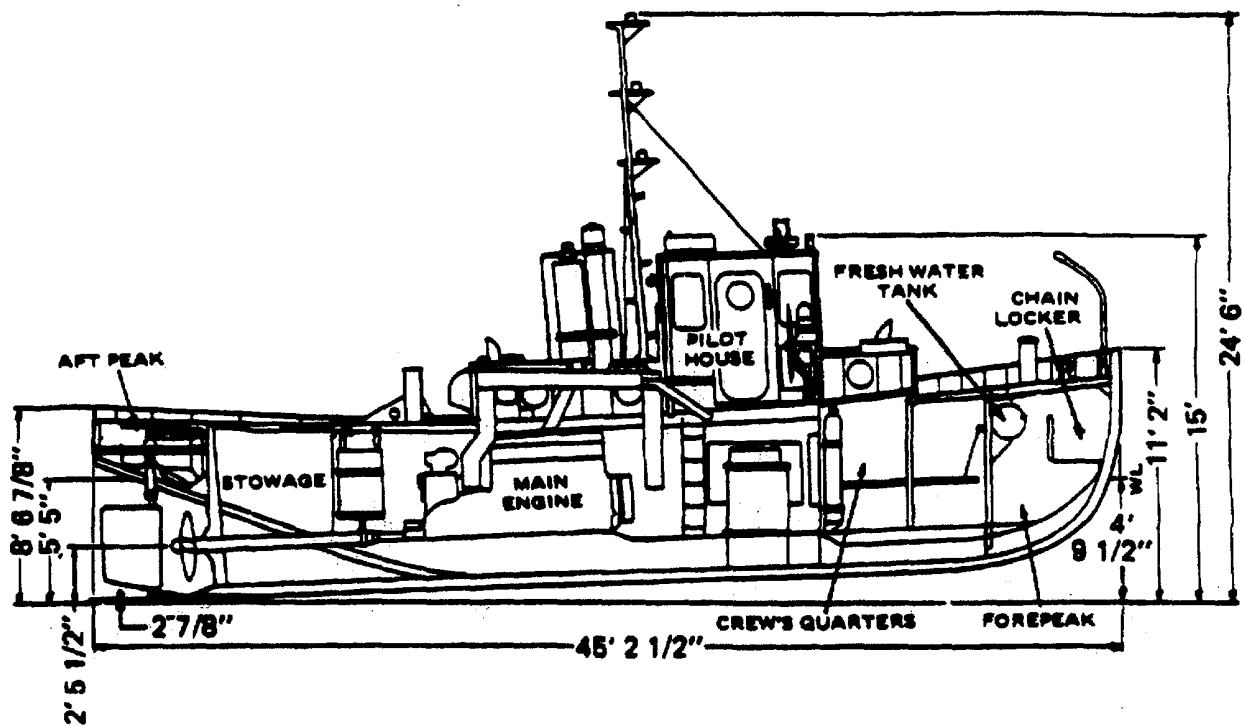

Inboard Profile

Tug, 200 hp, Design 320 (Sheet 2 of 2)

**TUG, RIVER, 50 FT, SHALLOW DRAFT DESIGN 3013**

**PURPOSE:** To tow drive-on, drive-off barges.

**TRANSPORTABILITY:****ADMINISTRATIVE INFORMATION**

DESIGNATION- ST  
 NSN - 1925-00-651-5685  
 LIN - 70772  
 COST - \$40,100 (June 1993)  
 Type classification - STD-A

**PRINCIPAL CHARACTERISTICS****MOBILITY AND ENGINE DATA:**

Speed - 12 knots

Main propulsion engines:

Number - 2

Type - diesel

Horsepower - 450 shaft

Fuel consumption - 10.25 gal. (38.8 L) per hour

Propellers:

Numbers - 2

Description - Bronze, 38in. (97 c) diameter, 28 in. (71 cm) pitch

Generator, main vessel service:

Number 1

Current - dc

Output - 2 kw

Voltage- 120

Engine:

Number - 1

Type of drive - diesel

Horsepower - 10 hp 1,200 rpm

Hull and Accommodations Data:

Construction - Steel

Overall length - 50 ft (15.3 m)

Beam, molded - 13 ft. 4 in. (4 m)

Depth - 3ft 8 in. (1. m)

Capacity:

Fuel - 1,280 gal. (4,845 L)

Anchor ( 65 b (29.5 kg)

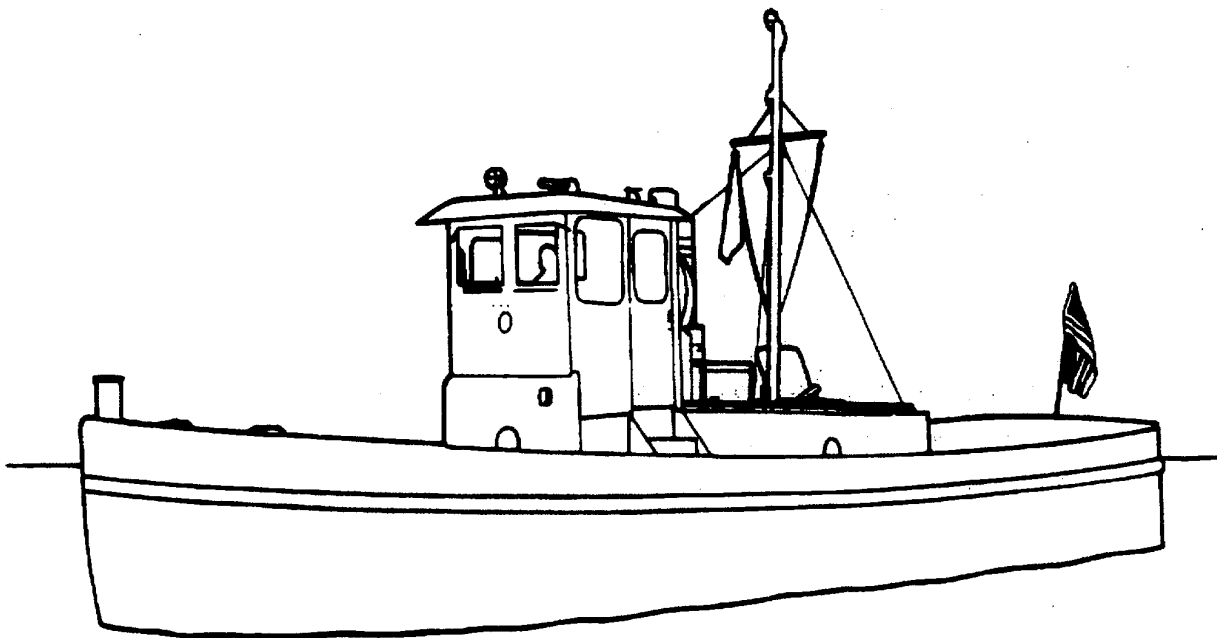

Tug, River, 50 ft., Shallow Draft, Design 3013

**TUG, LARGE, INLAND AND COASTAL - 128 ft.**

**PURPOSE:** This large tug (LT) is used for coastal and ocean towing and docking and undocking operations with large ocean vessels.

**TRANSPORTABILITY :****ADMINISTRATIVE INFORMATION**

DESIGNATION - LT

NSN - 1925-01-247-7 110

LIN - T68330

COST - \$1,250,000 (June 1993)

CTA - 50-909

Type classification - Standard 7/13/87

Specification No. - Circular of requirements (COR) Army Large Tug (LT) 20 January 1987

**PRINCIPAL CHARACTERISTICS****MOBILITY AND ENGINE DATA:**

Speed:

Light- 13.5 knot (25 km/hr)

Loaded - 12 knots (22 km/hr)

Cruising range:

Light - 5000 nautical miles (9,265 km)

Main propulsion engines:

Number - 2

Type - EMID 645F7B

Horsepower - 2550 bhp @ 900 rpm

Bollard pull - 58 LT

Fuel consumption - 168 gal. (636 L) per hour

Propellers:

Number - 2

Description - Bronze, fixed pitch, 11 ft. (3.4 m) diameter

Generators:

Number - 2 3408 0-TA-JW

Current -ac

Output- 275 kw

Voltage- 120

Engines:

Number - 2

Type of drive - diesel - Caterpillar

## Hull and Accommodations Data:

## Construction -

Overall length - 128 ft. 4 in. (39 m)

Beam, molded - 36 ft. (11 m)

Depth, molded - 10 ft 10 in. (3.3 m)

## Displacement:

Light - 786 long tons (799 t)

Loaded - 1057 long tons (1074 t)

## Draft:

## Light:

Aft - 14 ft. 4 in. .4 m)

## Loaded:

Aft - 16 ft. 10 in. (.1 m)

## Freeboard, mean:

Light - 5 ft. 10 in. (1.8 m)

Loaded - 3 ft. (92 cm)

## Capacity:

Fuel - 68,478 gal. (259,189 L)

Lube oil - 2495 gal. (9,444 L)

## Sea water ballast:

Aft peak - 21,272 gal. (80,515 L)

Crew accommodations --5 officers, 15 crew

## Anchors ():

Type - 85 lb (38.6 kg) "Danforth" Mark N

## Anchor chains (2)

## Safety Equipment:

## Firefighting equipment:

Aurora 413 2 x 2-1/2 x 9

## Lifeboats

Number - 2

Type - 25 man

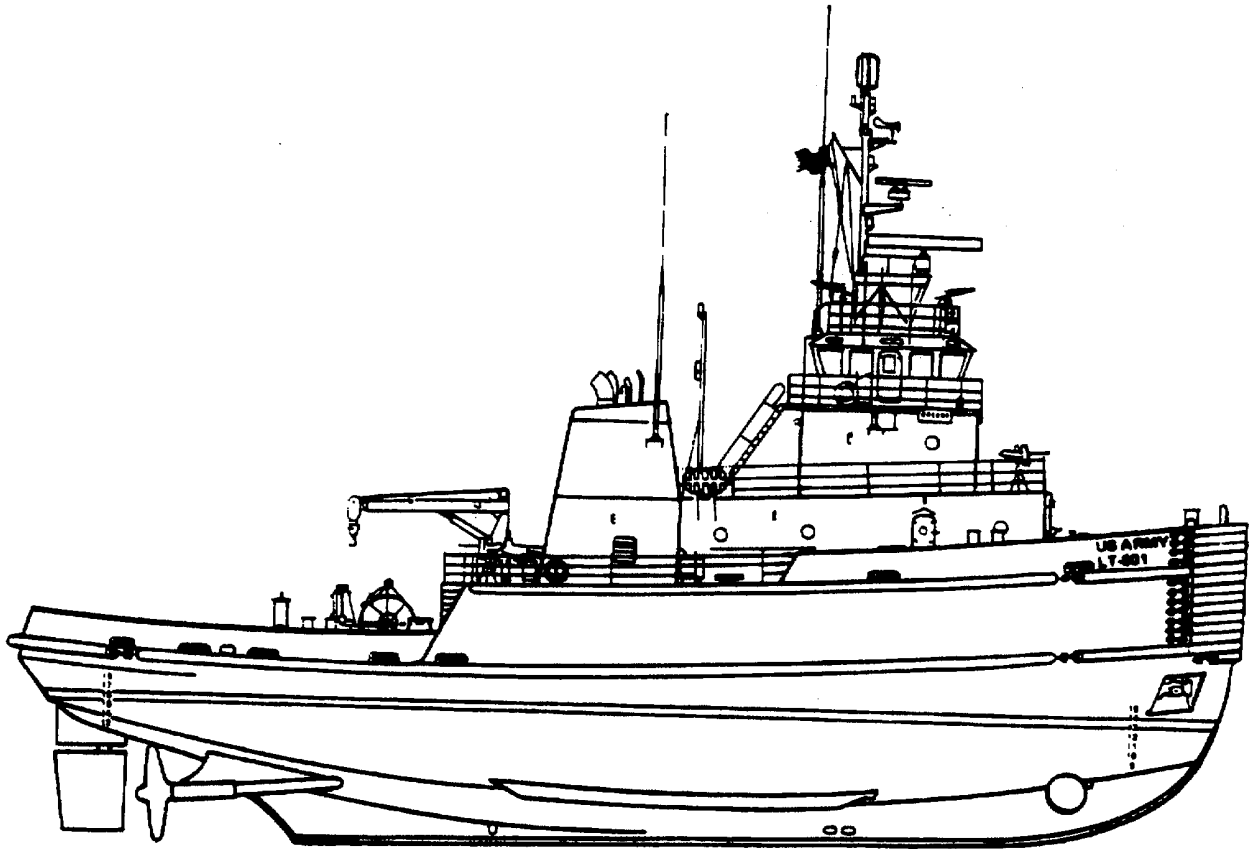

*Inland and Coastal Large Tug - 128 ft.*

TUG, ANCHOR HANDLING / TUG SUPPLY VESSEL

PURPOSE: Used as an anchor handling vessel, tug, and supply vessel.

TRANSPORTABILITY:

ADMINISTRATIVE INFORMATION

DESIGNATION -  
NSN - 1925-01-323-2586  
LIN- N/A  
COST - \$250,000 (June 1993)

PRINCIPAL CHARACTERISTICS

MOBILITY AND ENGINE DATA:

Speed:

About 15 knots (28 km/hr)

Main propulsion engines:

Number - 2

Type - 2430 bhp Alpha diesel, 18V 23HV,

Horsepower - 5000 bhp @ 2500 rpm



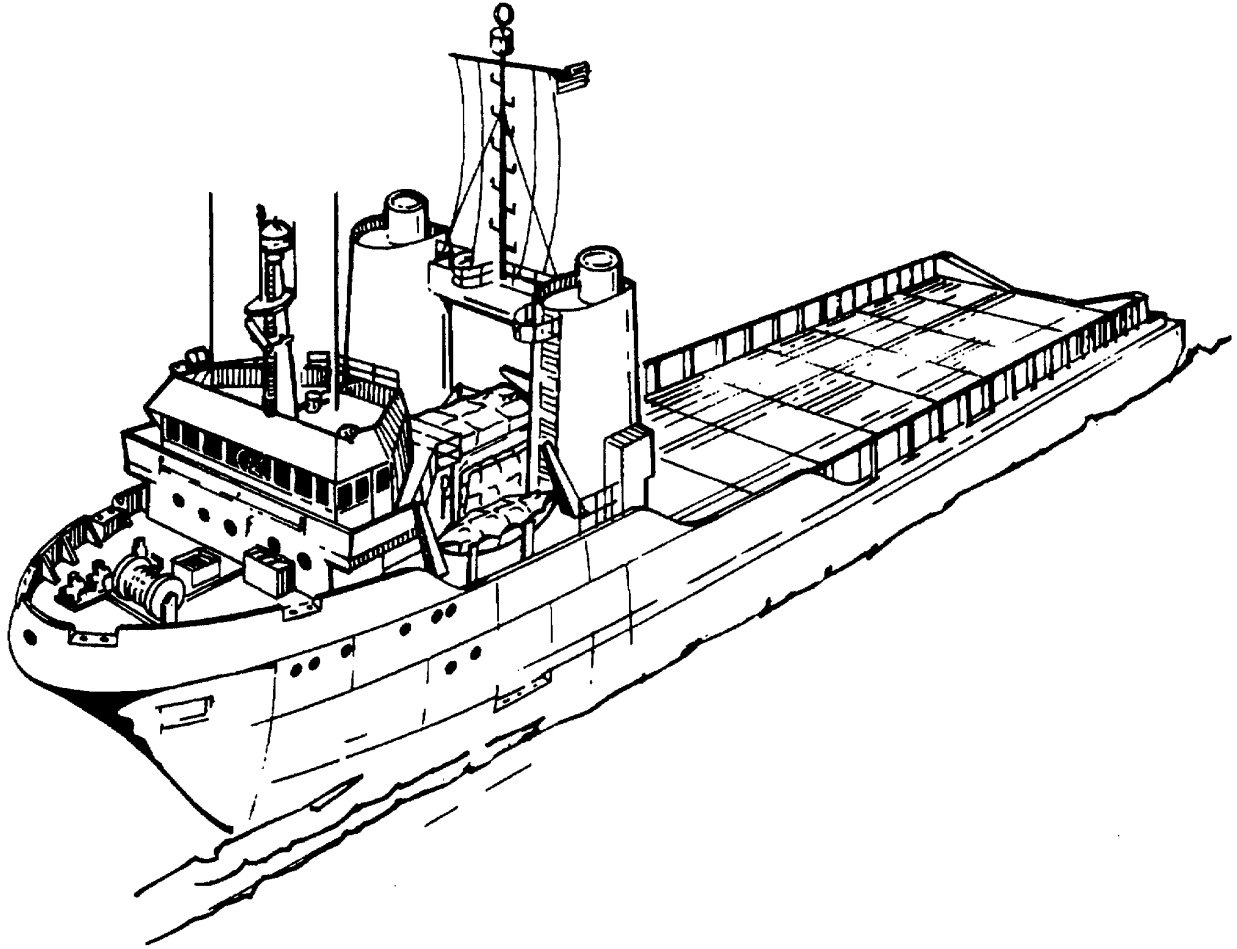

*Tug, Anchor Handling / Tug Supply Vessel*

---

Section III. LANDING CRAFT

3-74

## LANDING CRAFT, MECHANIZED, 73 FT 8 IN., LCM-8, MOD-0

PURPOSE: Transport cargo, troops and vehicles from ship-to-shore, shore-to-shore, or in retrograde movements. May be utilized for lighterage and utility work in harbors.

TRANSPORTABILITY: Can be carried to overseas destination as deck cargo aboard large vessels.

## ADMINISTRATIVE INFORMATION

DESIGNATION - LCM MARK VIII, MOD 0

NSN- 1905-00-267-1097

LIN - T68330

COST - \$174,650 (May 1992)

TA - 50-941

Type classification - STD-A

Specification - Navy

## PRINCIPAL CHARACTERISTICS

## MOBILITY AND ENGINE DATA:

## Speed:

Light - 11 knots (20.4 km/hr)

Loaded - 9 knots (16.7 km/hr)

## Cruising range:

Light - 332 nautical miles (615 km)

Loaded - 271 nautical miles (502 km)

## Main propulsion engines:

Number - 2, twin bank engines

Type - diesel

Horsepower - 300 bhp @ 1800 rpm each bank

Fuel consumption - 21.5 gal. (81.4 L) per hour

## Propellers:

Number - 2

Description - Manganese bronze, 3-blade, 34 in. (86 cm) diameter, 24 in. (61 cm) pitch

Generators, battery charging:

## NOTE

Some LCM-8s have 70 amp alternators. All 28.5 vdc generators are to be replaced by the alternator.

Number - 2

Current - d

Output - 500 watts

Voltage - 28.5

Type of drive - belt - main engine

## Hull and Accommodations Data:

## Construction- Steel

Overall length - 73 ft. 8 in. (22.5 m)

Beam, overall - 20 ft. 11-3/4 in. (6.4 m)

Depth, molded - 9 ft 5 in. (2.9 m)

## Displacement:

Light - 57.8 long tons (58.7 t)

Loaded - 111.4 long tons (113.2 t)

## Draft:

## Light:

Forward - 3 ft. (92 cm)

Mean - 3 ft. 3 in. (1 m)

Aft - 3 ft. 6 in. (1.1 m)

## Loaded:

Mean - 4 ft. 6 in. (1.4 m)

## Freeboard, mean:

Light - 6 ft. 1 in. (1.8 m)

Loaded - 5 ft. 4 in. (1.6 m)

## Capacity:

Fuel - 684 g. (3272 L)

Cargo - 53.5 long tons (54.4 t)

## Cargo space:

Length - 42 ft 9 in. (13 m)

Width - 14 ft. 6 in. (4.4 m)

Height - 4 ft. 3 in. (1.4 m)

Ramp opening - 14 ft. 6 in. (4.4 m)

Passengers - 200, combat-equipped

Crew - 5

## Anchor:

Number - 1

Type - 70 lb (34 kg) "Danforth" Mark IT

## Anchor line:

Number- 1

Type - 75 fathoms 137.2 m), 3 in. (8 cm) circumference nylon

## Safety Equipment:

## Firefighting equipment:

Four 15 lb (6.8 kg) C2 extinguishers

LANDING CRAFT, MECHANIZED, 74 FT., LCM-8, MOD-1

PURPOSE: Transport cargo, troops and vehicles from ship-to-shore, shore-to-shore, or in retrograde movement. May be utilized for lighterage and utility work in harbors.

TRANSPORTABILITY: Can be carried to overseas destination as deck cargo aboard large vessels.

ADMINISTRATIVE INFORMATION

DESIGNATION - LCM MARK VIII, MOD 1

NSN- 1905-00-935-6057

LIN - T36739

COST - \$162,612 (May 1992)

TA - 50-941

Type classification - STD-A

Specification - Navy

PRINCIPAL CHARACTERISTICS

MOBILITY AND ENGINE DATA:

Speed:

Light - 11 knots (20.4 km/hr)

Loaded - 9 knots (16.7 km/hr)

Cruising range:

Light - 332 nautical miles (615 km)

Loaded - 271 nautical miles (502 km)

Main propulsion engines:

Number - 2, twin bank engines

Type - diesel

Horsepower - 300 bhp @1800 rpm each bank

Starting:

Two - 24 vdc electric

Two hydraulic (3000 psi)

Fuel consumption - 21.5 gal. (81.4 L) per hour

Propellers:

Number - 2

Description - Manganese bronze, 3-blade, 34in (86 cm) diameter, 24 in. (61 cm) pitch

Alternators

Number - 2

Current - ac rectified to dc

Output - 70 amps

Voltage - 24

Type of drive - belt - main engine

## Hull and Accommodations Data:

## Construction Steel

Overall length - 74 ft. (22.6 m)

Beam, overall - 21 ft. 0-5/8 in. (6.4 m)

Depth, molded - 9 ft 5 in. (2.8 m)

## Displacement:

Light - 57.8 long tons(58.7 t)

Loaded - 111.4 long tons (113.2 t)

## Draft:

## Light:

Mean - 4 ft 6 n. (1 m)

## Loaded:

Mean - 5 ft 3 in. (1.6 m)

## Freeboard, mean:

Light - 6 ft.1 in. (1.8 m)

Loaded - 5 ft. 4 in. (1.6 m)

## Capacity:

Fuel - 684 gal. (3272 L)

Cargo - 53.5 long tons (54.4 t)

## Cargo space:

Length - 42ft. 9 in. (13 m)

Width - 14ft. 6 in. (4.4m)

Height - 4 ft. 3 in. (1.4 m)

Ramp opening - 14ft. 6 in. (4.4 m)

Passengers - 200, combat-equipped

Crew - 5

## Anchor:

Number- 1

Type - 70 b (34 kg) "Danforth" Mark II

## Anchor line:

Number - 1

Type - 75 fathoms 137.2 m), 3 in. (8 cm) circumference nylon

## Safety Equipment:

## Firefighting equipment:

Four 15 lb (6.8 kg) CO<sub>2</sub> extinguishers

## LANDING CRAFT, MECHANIZED, 74 FT (22 SSN), LCM-8, MOD-1 (SLEP)

PURPOSE: Transport cargo, troops and vehicles from ship-to-shore, shore-to-shore, or in retrograde movement. May be utilized for lighterage and utility work in harbors. (SLEP)

TRANSPORTABILITY: Can be carried to overseas destination as deck cargo aboard large vessels.

## ADMINISTRATIVE INFORMATION

DESIGNATION - LCM MARK VIII, MOD 1

NSN- 1905-01-284-247

COST - \$162,612 (May 1992)

TA - 50-941

Type classification - STD-A

Specification - Navy

## PRINCIPAL CHARACTERISTICS

## MOBILITY AND ENGINE DATA:

Speed:

Loaded - 9 knots (16.7 km/hr)

Cruising range:

Loaded - 271 nautical miles (502 km)

Main propulsion engines:

Number - 2

Type - diesel, 2 cycle, (V127 1)

Horsepower - 400 shaft horsepower @ 2100 rpm each engine

Starting:

Two - 24 vdc electric

Two hydraulic (3000 psi)

Fuel consumption - 26 gal. (98 L) per hour

Propellers:

Number - 2

Description - Manganese bronze, 3-blade, 34 in. (86 cm) diameter, 24 in. (61 cm) pitch

Alternators

Number - 2

Current - ac rectified to dc

Output - 70 amps

Voltage - 24

Type of drive - belt - main engine

## Hull and Accommodations Data:

## Construction - Steel

Overall length - 74 ft. (22.6 m)  
Beam, overall - 21 ft. 0-5/8:in. (6.4 m)  
Depth, molded - 9 ft 5 in. (2.8m)  
Displacement:  
Light - 58.8 long tons (59.8 t)  
Loaded - 116 long tons (118 t)

## Draft:

Loaded:  
Mean - 4 ft. 6 in. (1.4 m)

## Freeboard, mean:

Loaded - 4 ft. 10 in. (1.5 m)

## Capacity:

Fuel - 684 g. (3272 L)  
Cargo - 53.5 long tons (54.4 t)  
Cargo space:  
Length - 42 ft. 9 in. (13 m)  
Width - 14 ft. 6 in. (4.4 m)  
Height - 4 ft. 3 in. (1.4 m)  
Ramp opening - 14 ft. 6 in. (4.4 m)  
Passengers - 200, combat-equipped  
Crew- 6

## Anchor:

Number - 1  
Type - 70 lb (34 kg) "Danforth" Mark II

## Anchor line:

Number- 1  
Type - 75 fathoms 137.2 m), 3 in (8 cm) circumference nylon

## Safety Equipment:

Firefighting equipment:  
Four 15 lb (6.8 kg) CO<sub>2</sub> extinguishers



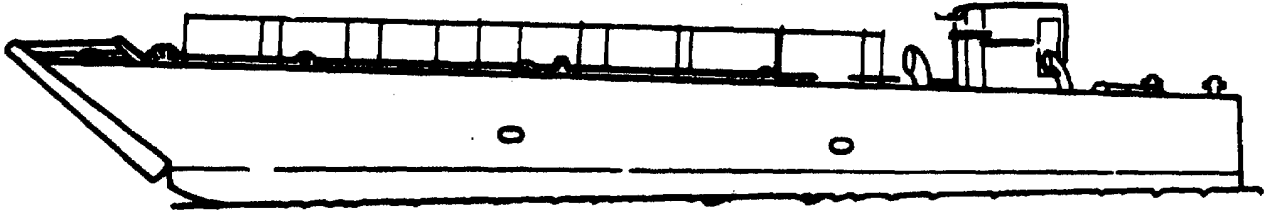

*Landing Craft, Mechanized, 74 ft., LCM-8 (Sheet 1 of 2)*

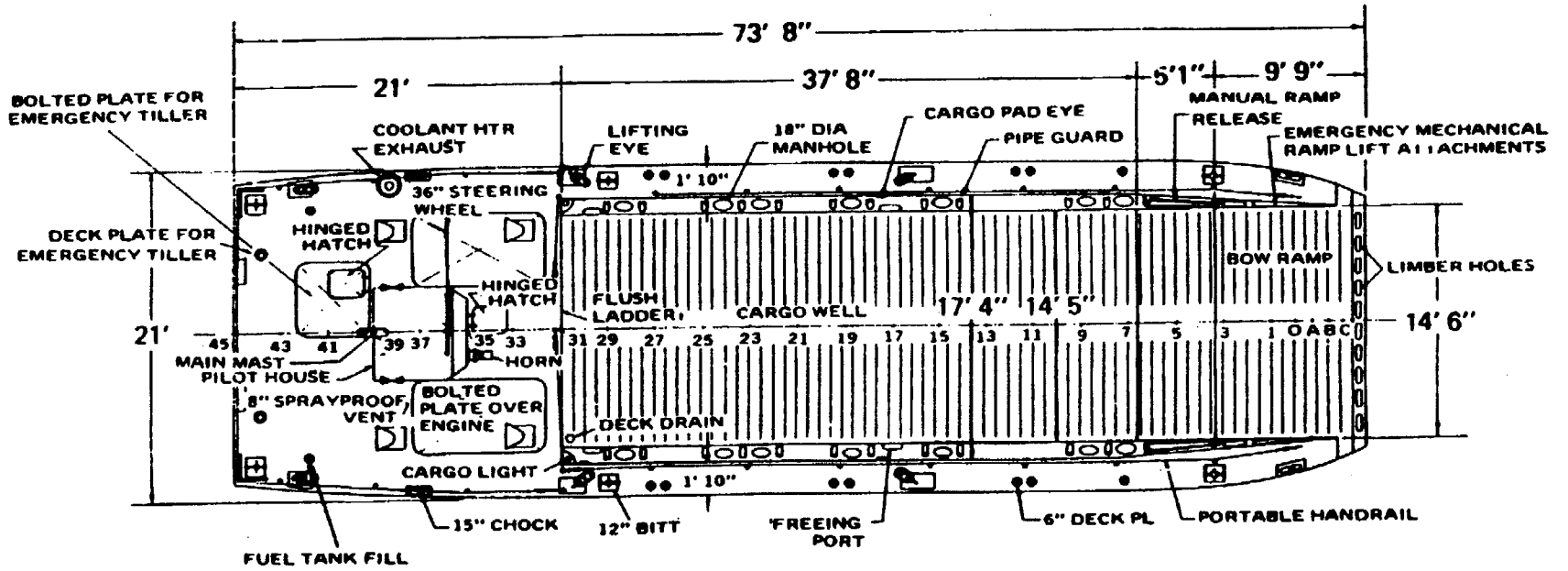

## LANDING CRAFT, UTILITY, 135 FT. (41 M), LCU-1667 &amp; 1671 CLASS

PURPOSE: To transport cargo, troops and vehicles from ship-to-shore, shore-to-shore, or in retrograde movements. May be utilized for lighterage and utility work in harbors.

TRANSPORTABILITY: Can be deck-loaded on LS, commercial bulk carriers, heavy lift ships, or carried in the well deck of an LSD. Under ideal conditions, it can operate under its own power for limited distances.

## ADMINISTRATIVE INFORMATION

DESIGNATION - LCU 1600

NSN - LCU 1667 Class - 1905-00-168-5764

LCU 1671 Class - 1905-01-009-1056

LIN - L36876

COST - LCU 1667 Class - \$1,390,625 (June 1993)

- LCU 1671 Class - \$1,30,000 (June 1993)

CTA - 50-909

Type classification - STD-A

Specification - Navy

## PRINCIPAL CHARACTERISTICS

## MOBILITY AND ENGINE DATA:

## Speed:

Light - 11 knots (20.4 km/hr)

Loaded - 11 knots (20.4 km/hr)

## Cruising range:

Light - 1200 nautical miles (2222 km)

Loaded - 1200 nautical miles (2222 km)

## Main propulsion engines:

Number - 2

Type - 2 cycle diesel, (7122-7000) (12V71)

Horsepower - 425 shaft horsepower @ 2300 rpm (each engine)

Fuel consumption - 26 gal. (98.4 L) per hour

## Propellers:

Number - 2 - One right-hand and one left-hand

Description - Manganese bronze, 4-blade, 48 in. (1.2 m) diameter, 42 in. (1 m) pitch, 395 lbs. (179 kg)

## Generators:

Number - 2

Current - ac

Output - 40 kw

Voltage - 420C25 V

Type drive - diesel (1033-7005)

Horsepower - 86 @ 1800 rpm

## Hull and Accommodations Data:

## Construction - Steel

Overall length - 135 ft. 1-5/16 in. (41.2 m)

Length between perpendiculars - 134ft. (4.8 m)

Beam, molded - 29 ft. 9-1/8 in. .1 m)

Depth, molded to vehicle deck (No camber, no sheer) - 8 ft (2.4 m)

## Displacement:

Light- 204.7 long tons (207.9t)

Loaded - 390 long tons (396.2 t)

Landing condition - 375.7 long tons (381.7 t)

## Draft:

Light: (Above bottom of keel at perpendiculars)

Forward - 3 ft. 6 in. (L1.1 m)

Mean - 4 ft. 6 i. (1.4 m)

Aft - 5 ft. 6 in. (1.7 m)

Loaded: (Above bottom of keel at perpendiculars)

Forward - 3 ft. 11-3/4 in. (1.2 m)

Mean - 6 ft. 7-12 in. (2 m)

Aft - 6 ft. 7-1/2 in. (2 m)

## Capacity:

Fuel - (95% full) 3290ga. (12,453 L)

Potable water - 3598 ga. (13,618 L)

Lube oil - 199 gal. (753 L)

Sewage holding tank - 500 ga. (1893 L)

Cargo - Bulk - 184 long tons (187 t)

## Cargo space:

Length - 105 ft. (32 m)

Width - (at narrowest point) 17 ft. (5.1 m)

## Ramp opening:

Bow - 15 ft. 1 in. (4.6 m)

Stern gate - 19 ft. (5.8 m)

## Crew:

Enlisted men - 12

Officers - 2

## Anchors:

Number - 2 (One ) spare)

Type - 1500 lb (681 kg) "Danforth" stern

## Anchor cable:

Number- 1

Type- 150 fathoms (274.3 m), 1-1/4 in. (32 cm), 6ft. X 37 ft. (1.8 m x 113 m) improved plow steel

Anchor winch:

Number - 1

Winch speed range - 9 ft. per minute @ 35,000 lbs. (4,830 m/kg) torque

Type drive - diesel thru torque converter

Engine - 2 cycle diesel (1044-7000)

Horsepower - 115 @ 1800 rpm

Safety Equipment:

Firefighting equipment:

Twelve 2-34 lb (1.2 kg) portable dry chemical type

For 20 lb (9.1 kg) portable dry chemical type

Fixed Halon system, (6 lbs. (31.3 kg) p bottle):

fwd engine room - 2

aft engine room - 2

flammable liquid store room - 1

Foam liquid in cans - 12

Portable gasoline engine driven pump - 1

Fire pump, electric driven (440 vac, 30 hp) 125 psi (8.8 kg/cm<sup>2</sup>) discharge - 2

Liferaft, inflatable, 15-man - 2

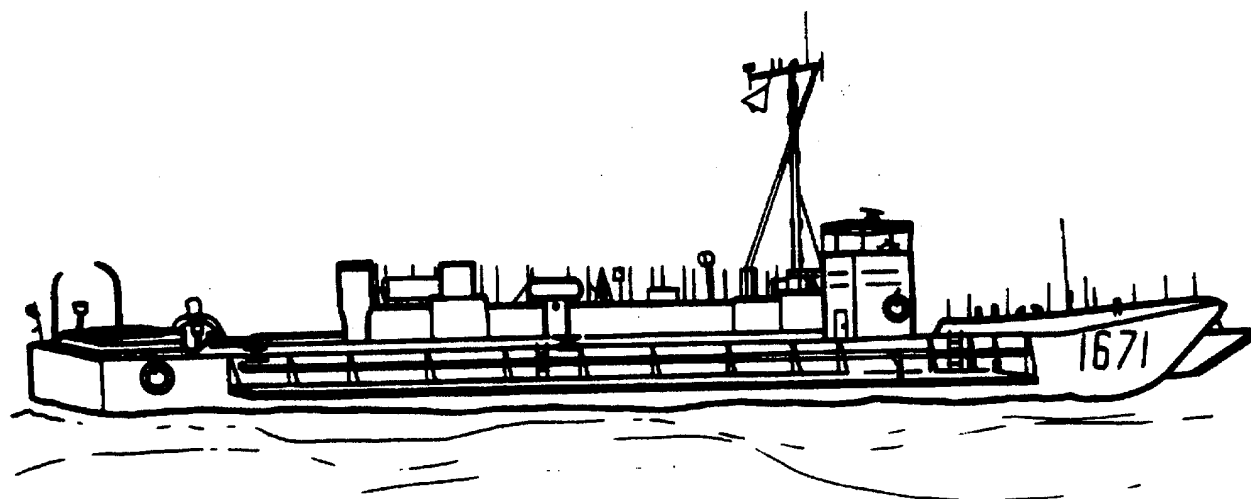

*Landing Craft, Utility, 135 ft., LCU-1667 & -1671 Class*

## LANDING CRAFT, UTILITY, 174 FT (56 M), LCU-2000 CLASS

**PURPOSE:** The LCU is designed to transport cargo from ships off-shore to shore and to transport cargo to areas that cannot be reached by ocean go vessels. The LCU can carry rolling stock (trucks, tanks, and other vehicles) and dry cargo. The vessel can operate in coastal waters and on the open ocean. It can beach and retract itself on remote coastlines and undeveloped port areas. Because of its shallow draft, the LCU can carry cargo from deep drafted ships to shore in ports or areas too shallow for larger ships. The LCU is also capable of deploying overseas under its own power.

**TRANSPORTABILITY:** Can be deck-loaded on LS, commercial bulk carriers, heavy lift ships, or carried in the well deck of an LSD. Can be deployed to overseas destinations under its own power.

## ADMINISTRATIVE INFORMATION

DESIGNATION - LCU 2000

NSN- 1905-01-154-1191

LIN - L36989

COST - \$5,000,000 (May 1992)

CTA - 50-909

Type classification - STD-A

Specification - Navy

## PRINCIPAL CHARACTERISTICS

## MOBILITY AND ENGINE DATA:

Speed:

Light - 12 knots (km/hr)

Loaded - 10 knots (km/hr)

Cruising range - 4500 nautical miles (km)

Main propulsion engines:

Number - 2

Type - turbo charged diesel, Cummins V16

Horsepower - 1250 (each engine)

Fuel consumption - 26 gal. (98.4 L) per hour

Propellers:

Number - 2

Generators:

Number - 3

Current - 60 Hz

Output - 250 kw (2), and 40kw (1)

Voltage - 240 Vac

Type drive - diesel engine driven

## Hull and Accommodations Data:

## Construction - Steel

Overall length - 174 ft. (53 m)

Beam, - 42 ft. (12.8 m)

## Displacement:

Light - 575 long tons (584 t)

Loaded - 1,087 long tons (1,104 t)

## Draft:

Mean - 8 t. (2.4 m)

Loaded - 8.85 ft. (2.7 m)

## Capacity:

Fuel - 92244 gal. (349,144 L)

Potable water - 4,618 gal. (17,479 L)

Lube oil - 444 gal. (1681 L)

Cargo - Bulk - 350 short tons (356 t)

## Cargo space:

Length - 100 ft. (30.5 m)

Width - 38 ft. (11.6 m)

## Ramp opening:

Bow - 16 ft. (4.9 m) wide by 22 ft. (6.7 m) long

## Crew:

Enlisted men - 11

Officers - 2

## Anchors - 3

Type - 2000 lb (kg) "Danforth" (1) and 1700 lb (kg) "Danforth" (2)

## Anchor cables - 3

Type - 6 - 7 shot each

## Anchor winch - 3

Type drive - elect. drive/hydraulic operated

## Safety Equipment:

## Firefighting equipment:

Fire pumps - 3 - select (2) and diesel driven (1)

Fire stations (hoses water/foam)- 3

Fixed Halon system, ( lbs. (kg) per bottle):

engine room - 1

paint locker - 1

## Rescue equipment:

Rescue/work boat - 1

Liferaft, inflatable, 15-man - 1



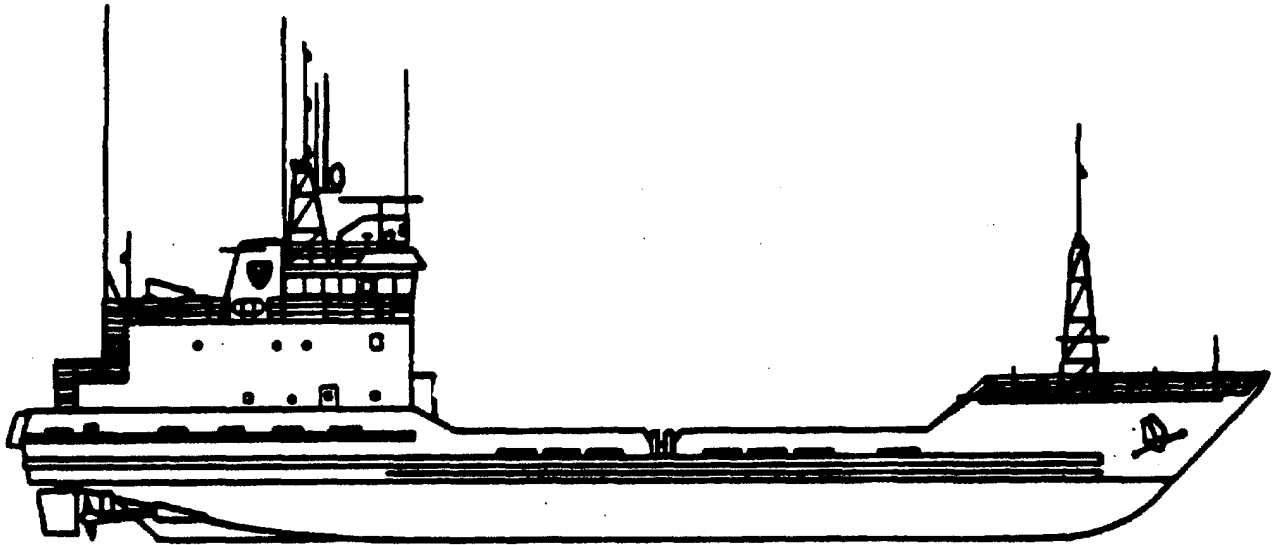

*Landing Craft, Utility 174 ft., LCU-2000 Class*

## LOGISTIC SUPPORT VESSEL (LSV)

PURPOSE: The LCU is designed transport DRY cargo in ocean, coastal, and inland waters.  
TRANSPORTABILITY: Can be deployed to overseas destinations under its own power.

## ADMINISTRATIVE INFORMATION

DESIGNATION - LSV

NSN - 1915-01-153-8801

LIN - V00426

COST - \$10,000,000 (June 1993)

CTA - 50-909

Type classification - STD-A

Specification - ARMY (NDI)

PRINCIPAL CHARACTERISTICS

MOBILITY AND ENGINE DATA:

Speed:

Light - 11.6 knot (249 km/hr)

Loaded - 12 knots (22 km/hr)

Cruising range:

Design - 5500 nautical miles (10,192 km)

Maximum - 8,350 nautical miles (15,473 kin)

Main propulsion engines:

Number- 2

Type - V16 (DTA) diesel engines(EMD) 16-645E6

Propellers:

Number - 2

Generators (Ship Service):

Number - 2

Current - 60 Hz

Output - 250 kw

Voltage - 440 Vac

Type drive - diesel engine driven

Generators, Emergency:

Number- 1

Current - 60 Hz, 3 phase

Output - 90 kw

Voltage - 440 Vac

Type drive - diesel engine driven

Hull and Accommodations Data:

Construction - Steel

Overall length - 272.75 ft. (83.2 m)  
 Length between perpendiculars - 256 ft. (78 m)  
 Beam, molded - 60 ft. (18.3 m)  
 Depth, molded to vehicle deck 16 ft. 6 in. (5 m)  
 Displacement - 4,199 long tons (4,266 t)

Draft:

Light:

Mean - 5.75 ft (1.75 m)

Loaded:

Mean - 12 ft. (3.7 m)

Capacity:

Fuel - 167,680 gal. (634,669 L)  
 Potable water - 33,000 gal. (124,905 L)  
 Cargo - Bulk - 2000 short tons (2032 t)

Cargo space - 10,684 sq. ft. (994 sq. m)

Ramp opening:

Bow - 26 ft. (.9 m) wide

Crew:

Enlisted men - 23  
 Officers - 6

Anchors - 3

Type - 4,369 lb (kg) "Danforth" stem

Anchor cables - 3

Type - drum with 1200 ft. wire rope (stem)

Anchor winch - 3

Type drive - hydraulically powered

Safety Equipment:

Firefighting equipment:

Fire pumps, electric driven - 2; portable gasoline engine driven pumps - 2  
 Fire stations (hoses water/foam) - 3  
 Fixed Halon system, (lbs. (kg) per bottle):  
     gen. room - 1; fwd engine room - 1; aft engine room - 1  
     bow thruster room - 1; flammable liquid storeroom - 1  
 Foam quid/water fire stations - 5

Rescue equipment:

Rescue/work boat - 1  
 Liferaft, inflatable, 25-man - 4

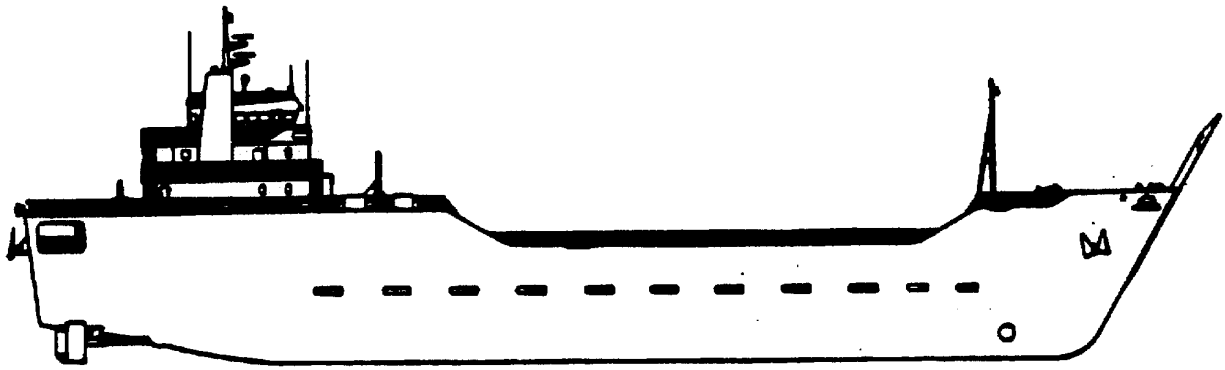

*Logistics Support Vessel (LSV)*

**Section IV. AMPHIBIOUS LIGHTERS**

**3-93**

**Lighter, Amphibious, Self-propelled, Diesel, 60-Ton, LARC-LX, Design 2303**

PURPOSE: To transport wheeled and tacked vehicles and general cargo from ship to beach and inland transfer points.

TRANSPORTABILITY: Can be deck-loaded on a larger vessel or carried in the well deck of an LSD for transportation to overseas destinations.

## ADMINISTRATIVE INFORMATION

DESIGNATION - LARC  
 NSN - 1930-00-392-2981  
 LIN - L67508  
 COST - \$390, 000 (June 1993)  
 CTA - 50-909  
 Type classification - STD-A  
 Specification - MIL-L-58017

## PRINCIPAL CHARACTERISTICS

## MOBILITY AND ENGINE DATA:

## Land Operation:

Forward speed, empty - 15.2 miles/hr (24.5 km/hr)  
 60-ton (61 t) load - 14 miles/hr (22.5 km/hr)  
 100-ton (101.6 t) load - 12.75 miles/hr (20.5 km/hr)  
 Reverse speed - 60-ton (61 t) load - 5 miles/hr (8 km/hr)

## Water Operation:

Forward speed, empty - 6.52 knots (12.1 km/hr)  
 60-ton (61 t) load - 6.08 knots (11.3 km/hr)  
 100-ton (101.6 t) load - 5.65 knots (10.5 km/hr)

## Cruising range with 60-ton (61 t) load:

Land - 150 statute miles (241.4 km)  
 Water - 75 nautical miles (138.9 km)

Gradability - 40 percent

Turing radius (on land) (minimum) - 75 ft. (22.8 m)

## Ground clearance, with 60-ton (61 t) load:

To bottom plating - 2 ft. 11 in. (89 cm)  
 To base of wheel column - 2 ft. 1/2 in. (62.2 cm)

## Tires (4):

Weight - 3000 lbs. (1362 kg) each  
 Type - tubeless, 48 ply, nylon  
 36.00 in. x 41 in. (91.4A cm x 1 m)  
 Diameter - 9.5 ft. (2.8 m)

## Freeboard:

## Light:

Forward - 7 ft. (2.1 m)  
 Aft - 5ft. 9 in. (1.7m)

Loaded - 60-ton (61 t):  
 Forward - 5 ft. (1.5 m)  
 Aft - 4 ft. 6 in. (1.3 m)

Capacity:

Fuel - 600 gal. (2271 L)  
 Hydraulic oil - 300 gal. (1135.5 L)  
 Lube oil - 60 g. (227 L)  
 Air, main and start - 21.4 cu. ft. (total) 150 psi (.6 cu. m (total) 10.5 kg2/m)

Cargo:

Normal - 60 short tons (54.4 t)  
 Emergency - 100 short tons (90.7 t)

Personnel:

Passengers:  
 Normal- 125  
 Emergency - 200  
 Crew - 4

Cargo space:

Length (frame 3 to frame 14, plus 1 ft. 3/8 in. (31.4 cm)) - 37 ft. 5/8 in. (11.2 m)  
 Width:  
 Between battens - 13 ft. 8 in. (4.1 m)  
 Without battens - 14 ft. (4.2 m)  
 Height:  
 Forward - 6 ft. 4 in. (19 m)  
 Aft - 4 ft. 6-1/2 in. (1.3 m)  
 Cubage (to deck level) - approximately 2,800 cu. ft. (78.4 cu. m)

Ramp opening, width - 14.5 ft. (4.3 m)

Anchor:

Hulls 5 through 18 - 70 lb (31.7 kg) "Danforth"  
 Hulls 10 through 48 - 70 lb (31.7 kg) "Danforth"

Anchor line (1):

Type - 380 ft. (115.8 m) of 5/8 in. (16 mm) wire

Anchor winch (1):

Line pull - 23,000 lbs. (10,442 kg)

Safety Equipment:

Firefighting equipment:  
 Two 15 lb (6.8 kg) CO2 extinguishers  
 One 5 lb (2.3 kg) CO2 extinguisher

Liferaft (1):

Type - 7 person, inflatable

Wheels - four, each with independent drive

Weight of wheel and rim assembly - 2,675 lbs. (1,214 kg)

Wheel track (front and re) - 23.5 ft. (7.1 m)

Wheelbase - 28.5 ft. (8.6 m)

Starting - power steering all wheels, selective front and rear

Main propulsion engines (4):

Type - diesel

Horsepower - 165 hp @ 2,100 rpm each

Fuel consumption - 38 gal. (143 L) per hour

Propellers (2):

Description - Manganese bronze, 4 blade, 48 in. (1.2 m) diameter, 30 in. (76.2 cm) pitch

Generators (2):

Current - dc

Windings - shunt

Volts - 24

Amps - 40

Rotation - clockwise

Type of drive - belt

Hull and Accommodations Data:

Construction - Steel

Length:

Overall - 62 ft. 6-11/16 in. (19 m)

Waterline with 60 ton load - 57 ft. 7 in. (17.5 m)

Width:

Overall - 26 ft. 7 in. (8.1 m)

Waterline - 25 ft. 9 in. (7.8 m)

Height:

Overall - 19 ft. 5 in. (5.9 m)

Reduced for shipping - 15 ft. 4 in. (4.6 m)

Weight:

Dry - 194,000 lbs. (88,076 kg)

Curb - 197,000 lbs. (89,438 kg)

Displacement, light - 87,956 long tons (89.4 t)

Draft (to bottom of wheels):

Light:

Forward - 6 ft. 2 in. (1.8 m)

Mean - 6 ft. 8 in. (2 m)

Aft - 7 ft. 5 in. (2.2 m)

Loaded - 60 tons (61 t):

Forward - 8 ft. 2 in. (2.5 m)

Mean - 8 ft. 5 in. (2.5 m)

Aft - 8 ft. 8 in. (2.6 m)



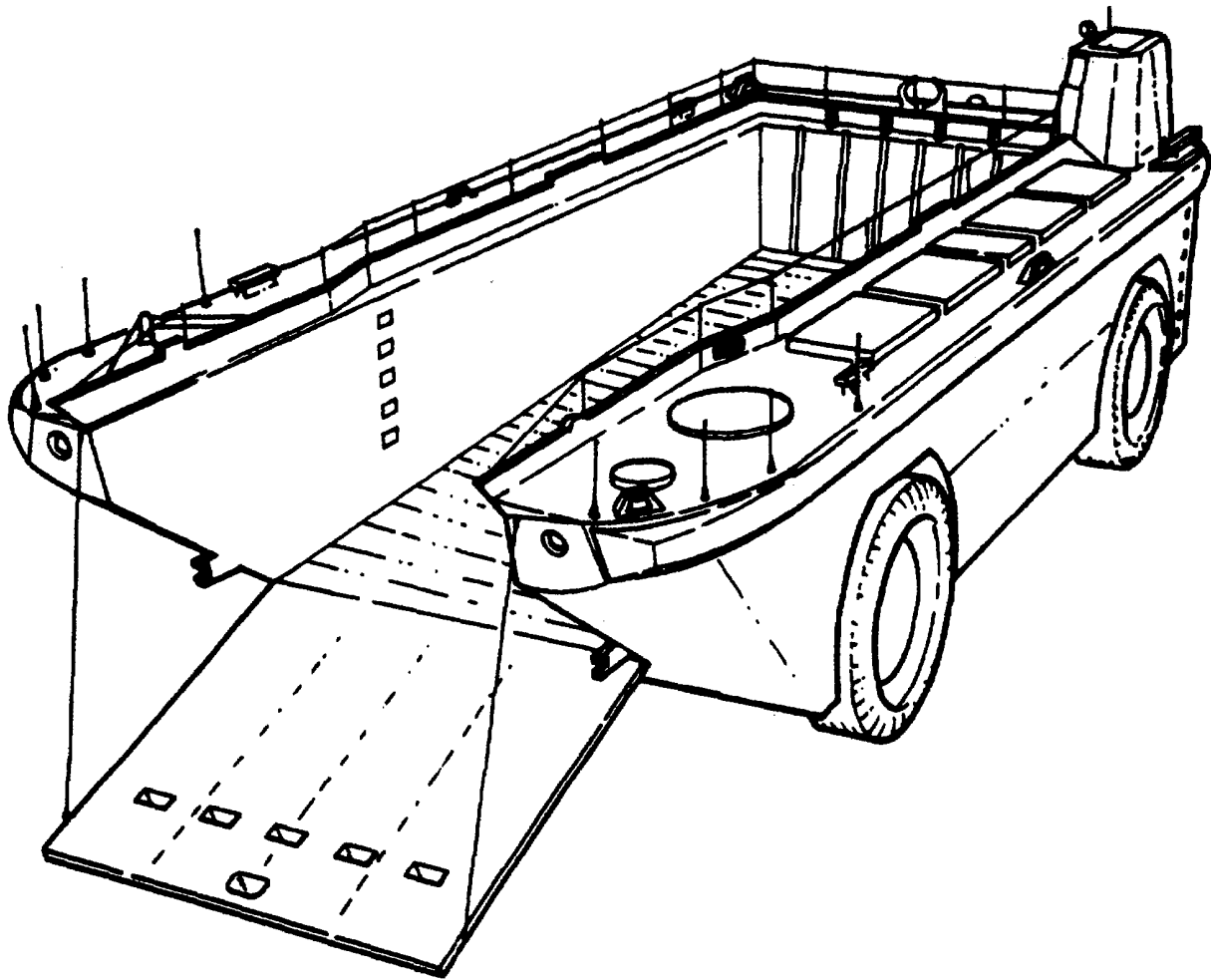

*Lighter, Amphibious, Self-propelled, Diesel, 60Ton, LARLX, Design 03*

**Section V. CAUSEWAY SYSTEMS**

**3-98**

**ROLL-ON / ROLL-OFF DISCHARGE FACILITY (RO/RO)**

**PURPOSE:** The RO/RO Discharge Platform Assembly is comprised of a floating platform, one platform fendering system, and one off-loading ramp. The RO/RO platform provides a means of off loading rolling stock from container shipping and to operate in a back-loading operation. The transportable ramp interfaces with the container ships and the platform. Two Side Loadable Warping Tugs are required to place and retrieve anchors.

**TRANSPORTABILITY:** Can be carried to overseas destinations assembled deck cargo.

**ADMINISTRATIVE INFORMATION**

**DESIGNATION - RO-RO**

**NSN - 1945-01-219-2109**

**LIN - C14572**

**COST - \$1,900,000 (June 1993)**

**Type classification - STD-A**

**PRINCIPAL CHARACTERISTICS**

**Construction - Steel**

**Causeway Section, Intermediate**

Number- 6

Length - 80 ft. (24.4 m)

Width - 24 ft. (7.3 m)

Depth - 4ft. (1.4m)

**Causeway, Combination Beach End and Sea End**

Number - 1

Length - 85 ft. (26 m)

Width - 24 ft. (7.3 m)

Depth - 4.5 ft. (1.4 m)

**Ramp, Calm Water**

Number - 1

Length - 120 ft. (37 m)

**RO/RO to Ship Fendering System**

Number- 1

**Generator Sets - (2):**

Type - Diesel (MIL-STD-G-5289/2)

Output - 10 kw

**Safety Equipment:**

**Firefighting equipment:**

One 15 lb. CO2 fire extinguisher

**Lifeboat:**

Number - 1

Capacity - 5 man, Zodiac, Mk 1GT

Outboard motor - 15 hp, OMC

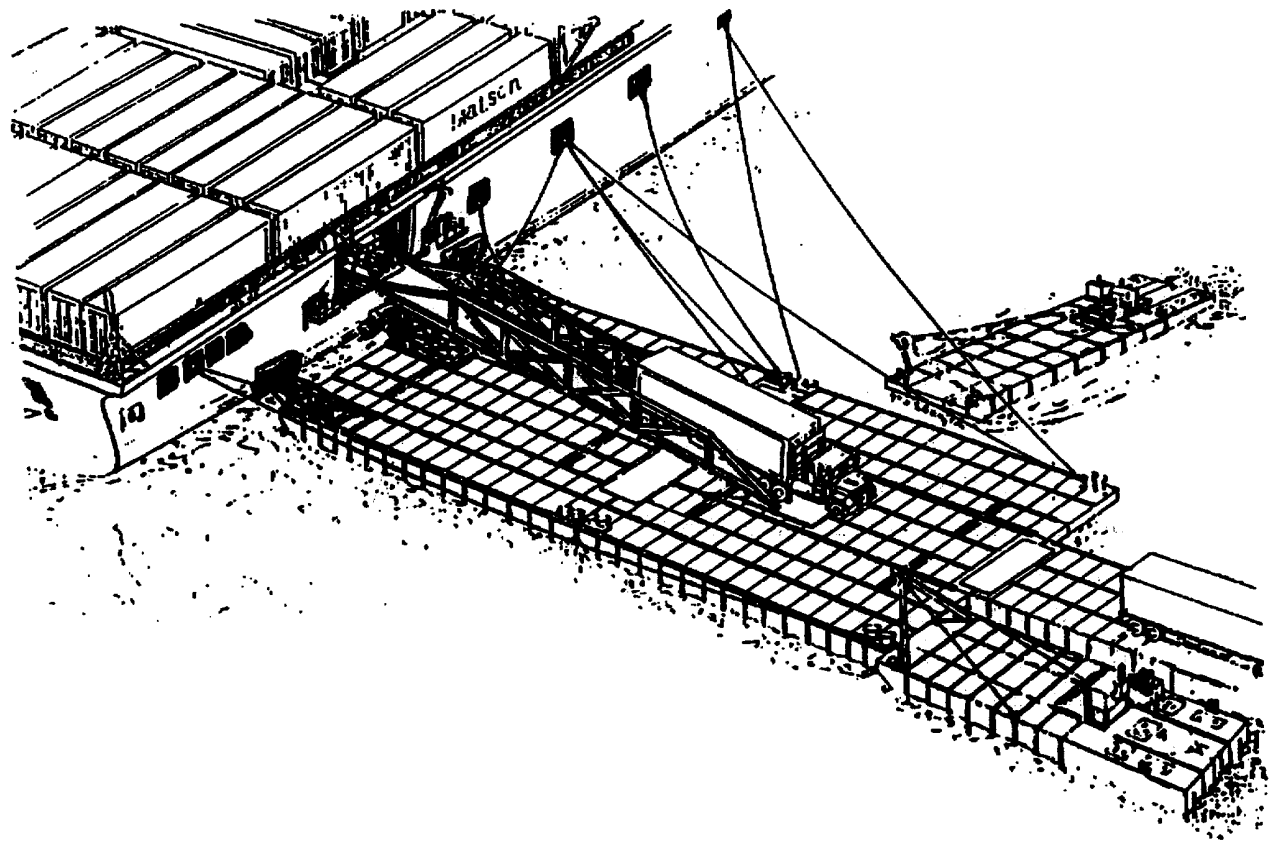

*Roll On / Roll Off Discharge Facility (RO/RO)*

**3-100**

**FLOATING CAUSEWAY SYSTEM**

PURPOSE: Provides an in-the-water temporary pier to which Army Lighterage may directly discharge rolling stock in undeveloped beach areas. Used in conjunction with SLWT.

TRANSPORTABILITY: ISO compatible and certified for air delivery.

**ADMINISTRATIVE INFORMATION**

DESIGNATION - FC

NSN - 1945-01-218-7268

LIN - C14504

COST - \$3,000,000 (June 1993)

Type classification - STD-B

**PRINCIPAL CHARACTERISTICS****Construction - Steel**

Length, overall - 1530 ft. (467 m)

Beam, molded - 24 ft. (7.3 m)

Depth, molded - 4.5 ft. (1.4 m)

**Intermediate Sections:**

Number - 15

Length - 80 ft. (24.4 m)

Width - 24 ft. (7.3 m)

Depth - 4.5 ft. (1.4 m)

**Combination Beach End and Sea End Sections:**

Number - 1

Length - 85 ft. 6 m)

Width - 24 ft.. (7.3 m)

Depth - 4.5 ft. (1.4 m)

**On-shore Mooring System:****On-shore Mooring Leg consists of the following components:**

4 ea.	Snatch Block
4 ea.	1" Master Link
16 ea.	Navmoor Anchor, 1000 lb.
4 ea.	Grip-hoist
8 ea.	15' by 5/8" Wire Rope
4 ea.	10' by 5/8" Wire Rope
12 ea.	5' by 5/8" We Rope
16 ea.	1-1/4" by 5" ID Ring
32 ea.	1/2" Connecting Link
16 ea.	1/2" by 16' Link Chain
36 ea.	1" Anchor Shackle, Bolt Type

Off-shore Mooring Leg consists of the following components:

48 ea.	1" Anchor Shackle, Bolt Type
192 ea.	3" Detachable Connecting Link
192 ea.	1" by 10' Stud Link Chain
144 ea.	24 "Buoy
576 ea.	15' by 1-1/4" Wire Rope
288 ea.	150' by 1-1/4" Wire Rope
1632 ea.	1-1/2" Anchor Shackle, Bolt Type
24 ea.	Navmoor Anchor, 2400 lb.

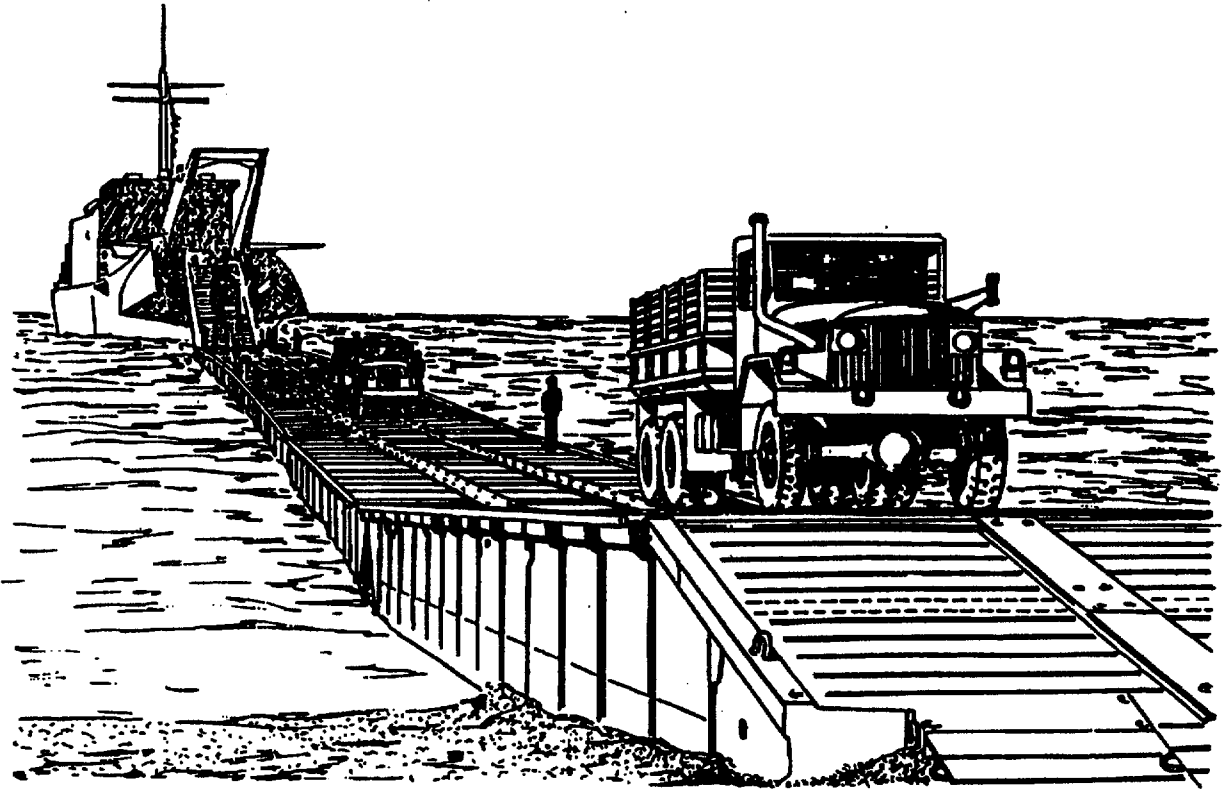

*Floating Causeway System*

3-103

**MODULAR CAUSEWAY SECTION**

PURPOSE: Provides an in-the-water temporary pier to which Army Lighterage may directly discharge rolling stock in undeveloped beach areas. Used in conjunction with SLWT.

TRANSPORTABILITY: ISO compatible and certified for air delivery.

ADMINISTRATIVE INFORMATION

DESIGNATION - MCS  
NSN - 1945-01-276-3644  
LIN- N/A  
COST - \$318,920 (June 1993)  
Type classification - STD-B

PRINCIPAL CHARACTERISTICS

Hull and accommodations data  
Construction - Steel  
Length, overall - 80 ft. (24.4 m)  
Beam, molded - 24 ft. (7.3 m)  
Depth, molded - 4.5 ft. (1.4 m)



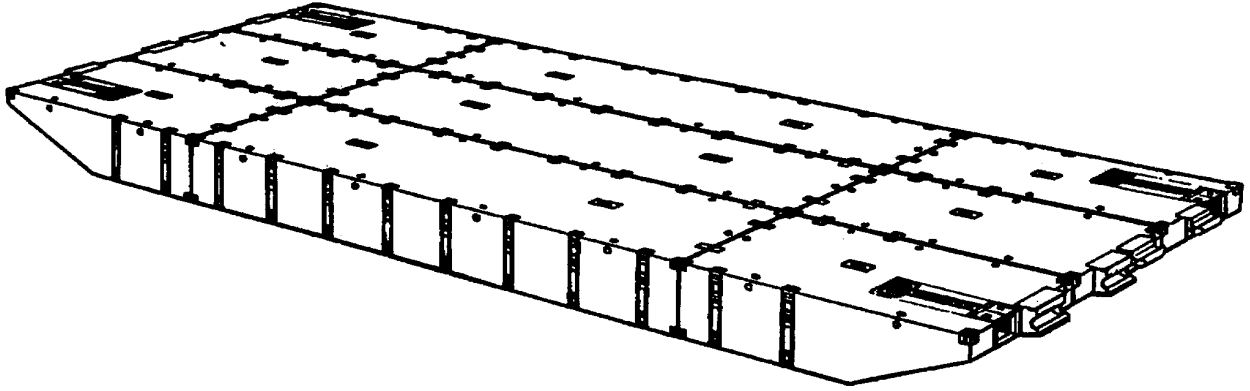

*Modular Causeway Section*

**3-105**

## SIDE LOADABLE WARPING TUG (SLWT)

**PURPOSE:** The Side Loadable Warping Tug (SLWT) consists of two each complete waterjet propulsion systems (one each port and one each starboard propulsion modules with a center service module. The propulsion and service modules are connected to a pontoon structure ten units long by three units wide and is equipped with a deck mounted winch, an "A" frame and a set anchor. The SLWT will perform near shore amphibious landing operations. It will set and remove anchors, position and tender causeway and associated equipment.

**TRANSPORTABILITY:** Can be deck-loaded on larger vessels for transportation to overseas destinations.

## ADMINISTRATIVE INFORMATION

DESIGNATION - SLWT  
 NSN - 1945-01-218-4669  
 LIN - W41707  
 COST - \$1,200,000 (June 1993)  
 Type classification - STD-A

## PRINCIPAL CHARACTERISTICS

Hull and accommodations data  
 Construction - Steel  
     Length, overall - 85 ft. (26 m)  
     Beam, molded - 21 ft. (6.4 m)  
     Depth, molded - 5 ft. (1.5 m)  
 Weight- 205,000 lbs. (93,070 kg)  
 Crew - 6  
 Main propulsion engine:  
     Number -2  
     Type - GM8V71TI diesel  
     Horsepower - 450  
     Fuel consumption - 23 gal. per hour  
 Propulsion unit:  
     Number- 2  
     Type - Hydrojet 30,000 gpm  
 Capacity:  
     Fuel - 600 gal. (2,271 L)  
 Cruising range - 10 hours @ 2100 rpm.  
 Firefighting equipment - Three 50 lb. (22.7 kg) CO2 modules

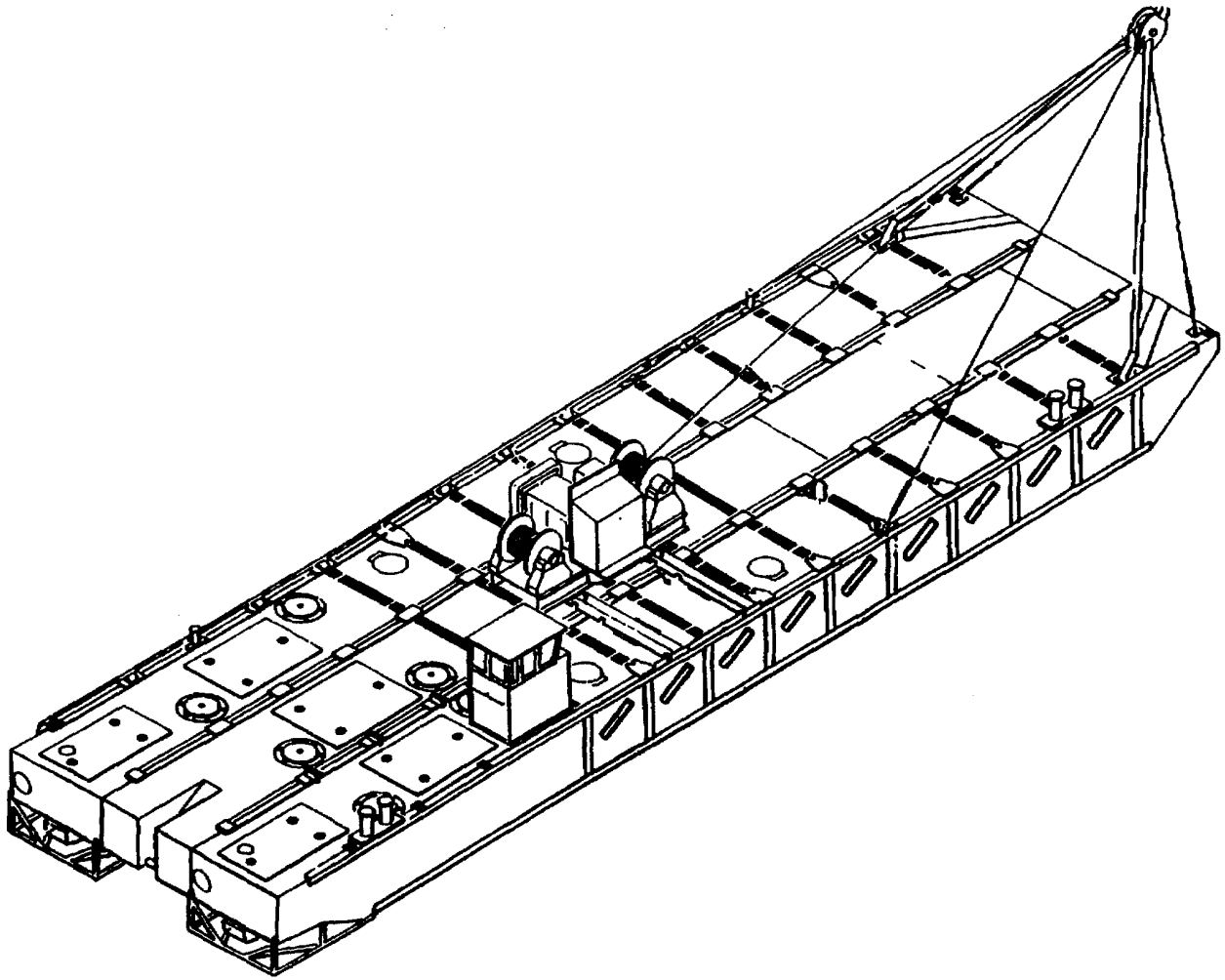

*Side Lodable Warping Tug (SLWT)*

**3-107/(3-108 blank)**

## APPENDIX A REFERENCES

---

- |                           |                                                                                                                                                     |
|---------------------------|-----------------------------------------------------------------------------------------------------------------------------------------------------|
| 1. Army Regulations (AR)  |                                                                                                                                                     |
| AR 55-19                  | Marine Casualties                                                                                                                                   |
| AR 56-9                   | Water Craft                                                                                                                                         |
| AR 310-25                 | Dictionary of United States Army Terms                                                                                                              |
| AR 310-50                 | Authorized Abbreviations and Brevity Codes                                                                                                          |
| AR 715-15                 | Implementing Procedures for Army Single Department<br>Procurement Assignments                                                                       |
| AR 750-1                  | Maintenance Concepts                                                                                                                                |
| 2. Field Manuals (FM)     |                                                                                                                                                     |
| FM 429-39                 | Marine Equipment Maintenance in the Army in the Field                                                                                               |
| FM 55-15                  | Transportation Reference Data                                                                                                                       |
| 3. Technical Manuals (TM) |                                                                                                                                                     |
| DA PAM 738-750            | The Army Maintenance Management System                                                                                                              |
| TM 5-210                  | Military Floating Bridge Equipment                                                                                                                  |
| TM 5-360                  | Port Construction and Rehabilitation                                                                                                                |
| TM 43-0139                | Painting Instructions for Army Mate6il                                                                                                              |
| TM 55-2000-200-L          | List of Applicable Publications (LOAP) US Army<br>Watercraft and Amphibians Excluding Communications<br>and Electronic Equipment                    |
| TM 55-375                 | Military Diving                                                                                                                                     |
| TM 55-501                 | Marine Crewman's Handbook                                                                                                                           |
| TM 55-503                 | Marine Salvage and Hull Repair                                                                                                                      |
| TM 55-509                 | Marine Engineman's Handbook                                                                                                                         |
| TM 55-510                 | Amphibious Lighter Operator's Handbook                                                                                                              |
| TM 55-511                 | Operation of Floating Cranes                                                                                                                        |
| TM 746-186                | Procedures for Rapid Deployment, Redeployment, and<br>Retrograde for Floating Equipment                                                             |
|                           | <b>LCM 8</b>                                                                                                                                        |
| TM 55-1905-202-12         | Operation and Maintenance of: LCM (8), MOD-O,<br>Landing Craft , Mechanized, Diesel, Steel, 69 feet,<br>Design LCM (8), MOD-O, NSN 1905-00-267-1097 |
| TM 55-1905-217-12         | Operation and Maintenance of: LCM (8), MOD-1,<br>Landing Craft, Mechanized, Diesel, Steel, 69 feet,<br>Design LCM (8), MOD-1, NSN 1905-00-935-6057  |

**Landing Craft Utility 1600 Class (LCU-1600)**

LO 55-1905-219-12	Lubrication Order
TM 55-1905-219-10-HR	Hand Receipt
TM 55-1905-219-14-1	Operator's, Organizational, Direct Support, and General Support Maintenance Manual
TM 55-1905-219-14-2	Operator's Mint., Chapter 2 (Continued)
TM 55-1905-219-14-3	Unit Maint., Chapter 3
TM 55-1905-219-14-4	Unit Maint., Chapter 3 (Continued)
TM 55-1905-219-14-5	Unit Maint., Chapter 3 (Continued)
TM 55-1905-219-14-6	Unit Mint., Chapter 3 (Continued)
TM 55-1905-219-14-7	Unit Maint., Chapter 3 (Continued)
TM 55-1905-219-14-8	Chapter 4
TM 55-1905-219-14-9	Chapter 4 (Continued)
TM 55-1905-219-14-10	Chapter 5 DS Maint.
TM 55-1905-219-14-11	Chapter 5 DS Mint. (Continued) and Chapter 6 GS Mint.
TM 55-1905-219-14-12	Appendix A thru F and Index
MWO 55-1905-219-50-1	Misc. Upgrade/Modernization
MWO 55-1905-219-55-1	Communications, Electronics, and Navigation (CEN)

**Landing Craft Utility 1600 Class (LCU-600)**

LO 55-1905-220-12	Lubrication Order
TM 55-1905-220-10-HR	Hand Receipt
TM 55-1905-220-14-1	Operator's, Organizational, Direct Support, and General Support Maintenance Manual
TM 55-1905-220-14-2	Operator's Maint., Chapter 2 (Continued)
TM 55-1905-220-14-3	Unit Maint., Chapter 3
TM 55-1905-220-14-4	Unit Maint., Chapter 3 (Continued)
TM 55-1905-220-14-5	Unit Maint., Chapter 3 (Continued)
TM 55-1905-220-14-6	Unit Maint., Chapter 3 (Continued)
TM 55-1905-220-14-7	Unit Maint., Chapter 3 (Continued)
TM 55-1905-220-14-8	Chapter 4
TM 55-1905-220-14-9	Chapter 4 (Continued)
TM 55-1905-220-14-10	Chapter 5 DS Maint
TM 55-1905-220-14-11	Chapter 5 DS Maint. (Continued) and Chapter 6 GS Mint.
TM 55-1905-220-14-12	Appendix A thru F and Index
MWO 55-1905-220-50-1	Misc. Upgrade/Modernization
MWO 55-1905-220-55-1	Communications, Electronics, and Navigation (CEN)

**Landing Craft Utility 2000 Class (LCU-2000)**

LO 55-1905-223-12	Lubrication Order
TM 55-1905-223-SDC	Shipboard Damage Control
TM 55-1905-223-10 (part 1)	Operator's Manual
TM 55-1905-223-10 (part 2)	Operator's Manual
TM 55-1905-223-24-1	Main Propulsion Engine
TM 55-1905-223-24-2	Min Reduction Gear
TM 55-1905-223-24-3	Ship's Service Generator
TM 55-1905-223-24-4	Emergency Generator Set
TM 55-1905-223-24-5	Bowthruster Engine
TM 55-1905-223-24-6	Bowthruster Waterjet
TM 55-1905-223-24-7	Reverse Osmosis Watermaker
TM 55-1905-223-24-8	Nr Compressor
TM 55-1905-223-24-9	Steering Gear System
TM 55-1905-223-24-10	Bow Ramp Assembly
TM 55-1905-223-24-11	Marine Sanitation System
TM 55-1905-223-24-12	Fire Pump Subsystem
TM 55-1905-223-24-13	Bilge/Ballast Pump
TM 55-1905-223-24-14	Gyro and Magnetic Compass Systems
TM 55-1905-223-24-15	Bow Anchor Windlass Subsystem
TM 55-1905-223-24-16	Stern Anchor Winch
TM 55-1905-223-24-17	Environmental Control Subsystem
TM 55-1905-223-24-18-1	Basic Craft (Part I) - Unit Maintenance
TM 55-1905-223-24-18-2	Basic Craft (Part II) - DS & GS Maint.
TM 55-1905-223-24P-1	Repair Parts and Special Tools List - RPSTL
TM 55-1905-223-24P-2	Repair Parts and Special Tools List - RPSTL
TM 55-1905-223-24P-3	Repair Parts and Special Tools List - RPSTL
TM 55-1905-223-24P-4	Repair Parts and Special Tools List - RPSTL

**Logistics Support Vessel (LSV)**

LO 55-1915-200-12	Lubrication Order
TM 55-1915-200-SDC	Shipboard Damage Control
TM 55-1915-200-10	Operator's Manual
TM 55-1915-200-24&P-1	Repair Parts and Special Tools List (RPSTL)
TM 55-1915-200-24&P-2	Repair Parts and Special Tools List (RPSTL)
TM 55-1915-201-24	Main Engine, Model Number 16-645E6
TM 55-1915-201-24P	Main Engine, Model Number 16-645E6- RPSTL
TM 55-1915-202-24&P	Reverse Reduction Gearbox, Model No. WAV 630-2240
TM 55-1915-203-24-1	Generator Set Engine, 250 KW, Model No. 3406-B
TM 55-1915-203-24-2	Generator Set Engine, 250 KW, Model No. 3406-B
TM 55-1915-203-24P	Generator Set Engine, 250 KW, Model No. 3406-B-RPSTL

TM 55-1915-204-24	Generator Set Engine, 90 KW, Model No. 3304-B
TM 55-1915-204-24P	Generator Set Engine, 90 KW, Model No. 3304-B - RPSTL
TM 55-1915-205-24	Bow Thruster Engine Set, Model No. 3306-B
TM 55-1915-205-24P	Bow Thruster Engine Set, Model No. 3306-B- RPSTL
TM 55-1915-206-24&P	Bow Thruster, Model No. S-152-L
TM 55-1915-207-24&P	Water Purification System, Model No. SW-1000 Series IV
TM 55-1915-208-24&P	Environment Control System
TM 55-1915-209-24&P	Compressed Air System, Model No. QR-25-350
TM 55-1915-210-24&P	Electro-Hydraulic Steering System
TM 55-1915-211-24&P	Bow Anchor Windlass and Bow Ramp Winch System, Model No. FCWH-6
TM 55-1915-212-24&P	Stern Anchor Winch and Stern Ramp Winch System (Jigger), Model No. HAW-19.0
TM 55-1915-213-24&P	Magnetic Compass
TM 55-1915-214-24&P	Marine Sanitation Plant, P/N RF-1500-FP-CBPN-D
TM 55-1915-215-24&P	Fire Pump System, Model No. 344A-BF
TM 55-1915-216-24&P	Bilge/Ballast Pump System, Model No. 344A-1
BF/411	
TM 55-1915-217-24&P	Gyrocompass, Model No. MARK 27, MOD 1
TM 55-1915-218-24&P	Ship Stores Refrigeration
TM 55-1915-219-24&P	Transmission Unit and Power Transfer Units, Model No. MK 37, MOD E
TM 55-1915-220-24&P	Gyro-Pilot, Model No. SRP 680
TM 55-1915-221-24&P	Compass Repeaters, Model No. 1976158
TM 55-1915-222-24&P	Centralized Control and Monitoring System
TM 55-1915-223-24&P	Commissary Equipment
TM 55-1915-224-24&P	Lube Oil/Fuel Oil Purifier, Model No. MAB103B-24
TM 55-1915-225-24&P	Fire Fighting System, Model No. HALON 1301
	<b>65 Foot Tug</b>
TM 55-1925-202-12	Organizational Maintenance Manual: Tug, Harbor Diesel, 600 HP Steel, 65-foot, Design 3004
	<b>100 Foot Tug</b>
TM 55-1925-204-12	Operator and Organizational Maintenance Manual: Tug, Harbor, Diesel, 1,200 HP Steel, 100-Foot, Design 3006, Hull Number LT1936 through LT1977 and LT2202
TM 55-1925-205-12	Organizational Maintenance Manual: Tug, Harbor Diesel, 1,200 HP Steel, 100-Foot, Design 3006, Hull Numbers LT2075 through LT2096

**Large Tug (L)**

LO 55-1925-207-12	Lubrication Order
TM 55-1925-207-SDC	Shipboard Damage Control
TM 55-1925-207-10-1	Operator Manual
TM 55-1925-207-10-2	Operator's Manual
TM 55-1925-207-24&P-1	Repair Parts and Special Tools List (RPSTL)
TM 55-1925-207-24&P-2	Repair Parts and Special Tools list (RPST)
TM 55-1925-208-24	Min Propulsion Engine
TM 55-1925-208-24P	Main Propulsion Engine - RPSTL
TM 55-1925-209-24-1	Ships Service Generator
TM 55-1925-209-24-2	Ship Service Generator
TM 55-1925-209-24P	Ships Service Generator - RPSTL
TM 55-1925-210-24	Emergency Generator Set
TM 55-1925-210-24P	Emergency Generator Set - RPSTL
TM 55-1925-211-24	Pump Drive Engine
TM 55-1925-211-24P	Pump Drive Engine - RPSTL
TM 55-1925-212-24&P	Bow Thruster Engine
TM 55-1925-213-24&P	Lubrication Oil Purification
TM 55-1925-214-24&P	Bow Thruster
TM 55-1925-215-24&P	Steering Gear System
TM 55-1925-216-24&P	Pumps
TM 55-1925-217-24&P	Reverse Osmosis Water Maker
TM 55-1925-218-24&P	Fuel Oil Coalescer
TM 55-1925-219-24&P	Maine Sanitation System
TM 55-1925-220-24&P	Oil Water Separator
TM 55-1925-221-24&P	Air Compressor
TM 55-1925-222-24&P	Propulsion Controls
TM 55-1925-223-24&P	Min Reduction Gear
TM 55-1925-224-24&PF	Environmental Control Subsystem
TM 55-1925-225-24&P	Engine Room Monitoring System
TM 55-1925-226-24&P	Commissary Equipment
TM 55-1925-227-24&P	Fighting System
TM 55-1925-228-24&P	Propulsion Shaft Couplings, Brakes, and Seals
TM 55-1925-229-24&P-1	Deck Machinery and Hydraulic System
TM 55-1925-2 29-24&P-2	Deck Machinery and Hydraulic System
TM 55-1925-230-24&P	Cathodic Protection System
TM 55-1925-231-24&P	Refrigeration Machinery
TM 55-1925-232-24&P	Life Raft/Work Boat
TM 55-1925-233-24&P	Laundry Equipment
TM 55-1925-234-24&P	Intercommunications



**Deck or Liquid Cargo Barge**

TM 55-1930-202-12	Operator and Organizational Maintenance Manual: Barge, Deck or Liquid Cargo, Non-Propelled, Steel, 578-Ton or 4,160 BBL, 120-Foot, Design 231B <b>LARC-LX</b>
TM 55-1930-203-10	Operator's Manual: Lighter, Amphibious (LARC-LX), Self-Propelled, Diesel, Steel, 60-Ton, 61-Foot, Design 2303, Hulls 5 through 60, NSN 1930-00-392-2981 <b>60 Ton Crane</b>
TM 55-1935-201-12	Operation and Organizational Maintenance Manual: Crane, Floating, Revolving, 60-Ton Capacity, Design 413 and 413D <b>Picket Boat</b>
TM 55-1940-201-12	Operator and Organizational Maintenance Manual: Boat, Picket, Design 4003, Hull Numbers J3741 through J3805
4. Technical Bulletins (TB)	
TB 5-360-1	Self-Elevating Barge
TB 5-4200-200-10	Hand Potable Fire Extinguishers Approved for Army Users
TB 34-9-62	Barge, Deck Cargo, Non-propelled, Steel, Sectionalized, Nesting, 81-Foot, Design 7001
TB 740-97-4	Preservation of Vessels for Storage
TB 43-002-26	Maintenance Expenditure Limits (MEL) for FSC Groups 19, 20 & 23; FSC Classes 1905,1915, 1925,1930,1935,1940, 1945, 2010, & 2305
TB 43-002-35	Maintenance Expenditure Limits (MEL) for FSC Group 22; FSC Classes 2210, 2220, 2230
TB 43-0117	Watercraft Electronics Configuration Directory
TB 43-0140	Instructions for Preparation of Request for Disposition or Waiver (DA Form 3590) for USA ATCOM Equipment and USA ATCOM, Non-Developmental Item (NDI)
TB 43-0141	Safe Handling, Maintenance Storage and Disposal of Radioactive Commodities Managed by U.S. Army Troop Support and Aviation Materiel Readiness Command (Excluding Aircraft Components)
TB 43-0142	Safety Inspection and Testing of Lifting Devices
TB 43-0143	Handling, Storage, Shipping, and Disposal of Surge Voltage Protector Tubes (Spark Gap Tubes)
TB 43-0144	Painting of Watercraft
TB 43-0153	Water Supply Afloat
TB 43-0154	Maintenance Expenditure Limits (MEL) for Military Standard Engines (Military Design) and Outboard Motor

TB 55-6-1	Standard Characteristics (Dimensions, Weight and Cube) for Transportability of Military Vehicles and Equipment
TB 55-1900-201-12/1	Application of Nonslip Walkway Compound; Harbor Tugs
TB 55-1900-201-45/1	Guide to Army Watercraft Survey Inspections, Repair Procedures and Repair Specifications Preparation
TB 55-1900-202-12/1	Watercraft Preventative Maintenance
TB 55-1900-202-12-2	Time Between Overhaul (TBO) for all Maine Engines
TB 55-1900-204-24	Arc Welding on Water-Borne Vessels
TB 55-1900-205-24	Watercraft Information and Reporting System (WIRS) Data Collector for Configuration Control
TB 55-1900-206-14	Control and Abatement of Pollution by Army Watercraft
TB 55-1900-207-24	Treatment of Cooling Water in Maine Diesel Engines
TB 55-1900-231-15	Prepositioned Watercraft: Preservation and Activation Procedures
TB 55-1900-232-10	U.S. army Towing Manual
TB 55-1905-202-34/1	Remote Magnetic Heading System (RMHS) Installation for: Vessel Design LCM-8 MOD-O FSN 1905-00-267-1097
TB 55-1905-202-34/1	Remote Magnetic Heading System (RMHS) Installation for: Vessel Design LCM-8 MOD-1 FSN 1905-00-95-6057 TB 55S-930-203-12B1 Installation of Ways, Stowing and Launching of BARC (LARC) from Cargo Vessels
TB 600-1	Procedures for Selection, Training, Testing and Qualifying Operators of Equipment Systems,
Excluding	Selected Watercraft and Aircraft, Managed/Supported by US Army Troop Support and Aviation Materiel Readiness Command
TB 750-105	Standards for Overseas Shipment

**5. Supply Bulletin (SB)**

SB 700-20

Army Adopted Items of Material

**6. Tables of Organization and Equipment (TOE)**

55-111-H4

Headquarters and Headquarters Company,  
Transportation Terminal Command C

55-116-H2

Headquarters and Headquarters Detachment  
Transportation Terminal Battalion

55-117-G

Transportation Terminal Service Company

55-118-H7

Transportation Terminal Transfer Company

55-128-G

Transportation Medium Boat Company

55-129-G

Transportation Heavy Boat Company

55-138

Transportation light Amphibian Company

55-139	Transportation Medium Amphibian Company
55-530-C	Lighter Amphibian LARC-Team FN
55-157	Transportation Floating Craft General Support Maintenance Company
55-500	Transportation Service Organization
55-158	Transportation Lighterage Maintenance Company Direct Support
55-530	Transportation Watercraft Teams
55-550	Watercraft Maintenance Teams

7. Common Table of Allowances (CTA)

CTA 50-909	Field and Gison Furnishings and Equipment
CTA 50-970	Expendable Items

8. Environmental Protection Publications and Directives

AR 200-1	Environmental Protection and Enhancement
AR 500-60	Disaster Relief
DOD Directive 5100.50	Environmental Control
DOD Directive 5030.41	Implementation, of National Oil and Hazardous Substance Pollution Contingency Plan
Executive Order 11572	Prevention, Control and Abatement of Environmental Pollution at Federal Facilities
CG-123, Sub-chapter D	U.S. Coast Guard Rules and Regulations for Tank Vessels
33 USC 1161, Part 610, Sec. 11 (B)	Federal Water Pollution Control Act
33 USC 1161, Part 610, Sec. 311 J)	Federal Water Pollution Control Act Amendments of 1972

## APPENDIX B

## INTERRELATIONS OF MEASUREMENTS

## LINEAR

1 Inch	= 2.54 centimeters (cm) = 0.0254 meters (m)
1 Foot	= 0.3048 meter
1 Yard	= 0.9144 meter
1 Fathom	= 6 Feet (ft) = 1.8288 meters
1 Cable	= 720 feet = 219.456 meters
Statute Mile	= 5280 feet = 1760 yards = 0.86897 nautical mile = 1.60934 kilometers (km)
1 Nautical Mile	= 6076.11549 feet = 2025.37183 yards = 1.15078 statute mile = 1.852 kilometers
1 Meter	= 100 centimeters = 39.37 inches (in) = 3.2808 feet = 1.09361 yards = 0.5468 fathoms
1 Kilometer	= 3280.8399 feet = 1093.6133 yards = 0.062137 statute mile = 0.53996 nautical mile = 1000 meters

## SURFACE AREA

1 Square Inch	= 0.006944 square feet (ft <sup>2</sup> ) = 6.452 square centimeters (cm <sup>2</sup> ) = 0.000645 square meter (m <sup>2</sup> )
1 Square Foot	= 144 square inches (in <sup>2</sup> ) = 0.11111 square yard (yd <sup>2</sup> ) = 0.0929 square meter (m <sup>2</sup> )
1 Square Yard	= 1296 square inches (in <sup>2</sup> ) = 9 square feet (ft <sup>2</sup> ) = 0.83613 square meter (m <sup>2</sup> )
1 Square Statute Mile	= 27,878.4 square feet (ft <sup>2</sup> ) = 2.589988 square kilometers

1 Square Centimeter	= 0.155 square inch (in <sup>2</sup> )
1 Square Meter	= 107639 square feet (ft <sup>2</sup> )
	= 1.19599 square yards
1 Square Kilometer	= 0.3861 square statute mile
	= 0.291553 square nautical mile

**VOLUME - CAPACITY**

1 Cubic Inch	= 16.387 cubic centimeters (cm <sup>3</sup> )
	= 0.01639 liter (L)
1 Cubic Foot	= 1728 cubic inches (in <sup>3</sup> )
	= 7.4805 U.S. gallons (gal)
	= 6.2288 Imperial gallons
	= 0.17811 barrel (bbl)
	= 28.317 liters
	= 0.028312 cubic meter (m <sup>3</sup> )
1 Cubic Yard	= 46,656 cubic inches (in <sup>3</sup> )
	= 27 cubic feet (ft <sup>3</sup> )
1 Gallon (U.S.)	= 231 cubic inches (in <sup>3</sup> )
	= 0.133681 cubic feet (ft <sup>3</sup> )
	= 0.83267 Imperial gallon
	= 0.023809 barrel
	= 3.78533 liters
1 Imperial Gallon	= 277.42 cubic inches (in <sup>3</sup> )
	= 0.160544 cubic feet (ft <sup>3</sup> )
	= 1.20094 gallon (U.S.)
	= 0.028594 barrel
	= 4.54596 liters
1 Barrel	= 9702 cubic inches (in <sup>3</sup> )
	= 5.6146 cubic feet (ft <sup>3</sup> )
	= 42 gallons (U.S.)
	= 34.9721 Imperial gallons
	= 158.984 liters
1 Liter	= 61.026 cubic inches (in <sup>3</sup> )
	= 0.035316 cubic feet (ft <sup>3</sup> )
	= 0.264178 gallon (U.S.)
	= 0.219975 Imperial gallon
	= 0.028594 barrel
1 Cubic Meter	= 61,022.592 cubic inches (in <sup>3</sup> )
	= 35.315 cubic feet (ft <sup>3</sup> )
	= 264.17 gallons (U.S.)
	= 219.97 Imperial gallons
	= 6.2898 barrels
1 Register Ton	= 100 cubic feet (ft <sup>3</sup> )
	= 2.831685 cubic meters (m <sup>3</sup> )

Measurement Ton = 40 cubic feet (ft<sup>3</sup>)  
 = 1 freight ton  
 = 1.13267 cubic meters (m<sup>3</sup>)

**VOLUME - WEIGHT**

1 Cubic Foot of Fresh Water = 62.428 pounds (max. density 4° C - 39.2° F)  
 1 Cubic Foot of Sea Water = 64 pounds  
 1 Cubic Foot of Ice = 56 pounds  
 1 Displacement Ton = 35 cubic feet of sea water  
 1 long ton

**WEIGHT**

1 Ounce = 437.5 grams  
 = 28.34952 grams  
 = 0.0625 pound  
 = 0.02835 kilogram  
 1 Pound = 0.45359 kilogram  
 1 Short Ton = 2000 pounds  
 = 0.892857 long ton  
 = 907.18474 kilograms  
 = 0.90718474 metric ton  
 1 Long Ton = 2240 pounds  
 = 1.12 short tons  
 = 1,016.0469 kilograms  
 = 1.016047 metric tons  
 1 Kilogram = 2.20462 pounds  
 = 0.0011 short ton  
 = 0.00098 long ton  
 1 Metric Ton = 2,204.6226 pounds  
 = 1.10231 short tons  
 = 0.98421 long tons  
 = 1000 kilograms

**POWER EQUIVALENTS**

1 Foot-Pound Per Second (ft-lb/sec) = 1.3557 watts  
 = 0.00182 horsepower  
 = 0.1383 kilogram-meters per second  
 = 0.00184 metric horsepower  
 1 Watt = 0.00134 horsepower  
 = 0.7376 foot-pounds per second  
 = 0.02 kilogram-meters per second  
 = 0.00136 metric horsepower  
 1 Horsepower = 550 foot-pounds per second  
 = 745.65 watts  
 = 76.04 kilogram-meters per second  
 = 1.014 metric horsepower

1 Kilogram- Meter Per Second	= 7.233 foot-pounds per second = 9.806 watts = 0.01315 horsepower
1 Metric Horsepower	= 0.01333 metric horsepower = 542.475 foot-pounds per second = 735.448 watts = 0.9863 horsepower = 75 kilogram-meters per second

**PRESSURES**

1 Pound Per Square Inch	= 2.30665 feet of water (column, max. density 40C) = 0.07031 kilograms per square centimeter (kg/cm <sup>2</sup> )
1 Foot of Water (Column)	= 0.43353 pounds per square inch (lbn <sup>2</sup> ) = 0.03048 kilograms per square centimeter
1 Kilogram Per Square Centimeter	= 14.2234 pounds per square inch (psi) = 32.8083 feet of water (column, max. density 4° C)

**SPEED**

1 Foot Per Second	= 20 yards per minute = 0.6818 statute miles per hour = 0.5925 knot = 0.3048 meter per second = 1.09728 kilometers per hour
1 Statute Mile Per Hour	= 88 feet per minute = 29.333 yards per minute = 0.86897 knots = 0.44704 meter per second = 1.6093 kilometer per hour
1 Knot	= 101.2686 feet per minute = 33.7562 yards per minute = 0.51444 meter per second = 1.852 kilometer per hour
1 Meter Per Second	= 196.8504 feet per minute = 65.6168 yards per minute. = 2.2369 statute miles per hour = 1.9438 knots = 3.6 kilometers per hour
1 Kilometer Per Hour	= 0.62137 statue miles per hour = 0.53996 knots
Sound in Dry Air (60° F at Sea Level)	= 1116.99 feet per second
Sound in 3.485 Percent Sea Water (60° F)	= 4945.37 fee per second

## INDEX OF EQUIPMENT

<u>Item</u>	<u>Page</u>
Barge, deck or liquid cargo, non-propelled, knockdown, design 218E	3-10
Barge, deck cargo, non-propelled, sectionalized, nesting, design 7001	3-27
Barge, deck cargo, non-propelled, ocean towing, 585 tons, design 231A	3-12
Barge, deck or liquid cargo, non-propelled, design 231B	3-14
Barge, liquid cargo, non-propelled, design 231C	3-16
Barge, deck cargo, non-propelled, harbors and inland waterways, design 7005	3-29
Barge, water purification, non-propelled	3-33
Boat, 65 ft., passenger, design 6013	
Boat, passenger and cargo, design 2001	3-47
Boat, picket, design 4002	3-39
Boat, picket, design 4003	3-42
Boat, picket	3-45
Bridge erection boat	3-37
Conversion kit, barge, deck enclosure	3-18
Crane, barge, 60-ton, design 413D	3-19
Crane, barge, 100-ton, design 264B	3-23
Floating causeway system	3-101
High speed ferry, passenger	3-51
Landing craft, mechanized, 73 ft. 8 in., LCM-8 (MOD-O)	3-75
Landing craft, mechanized, 74 ft., LCM-8 (MOD- 1)	3-77
Landing craft, mechanized, 74 ft., (22 SSN) LCM-8, MOD- 1 (SLEP)	3-79
Landing craft, utility, 135 t., (41 m), LCU-1667 & -1671 class	3-83
Landing craft, utility, 174 ft. (56 m), LCU-2000 d class	3-87
Lighter, amphibious, self-propelled, diesel, 60 ton, LARC-LX, design 2303	3-94
Logistics support vessel (LSV)	3-90
Modular causeway section	3-104



Pier, barge type, self-elevating, non-propelled, steel, 300 ft. long, 80 ft. wide, (91.5 m long, 24A m wide), design 7029	3-31
Propelling unit, outboard, design NAV-165	3-5
Propelling unit, design 9002	3-2
Propelling unit, outboard, design (Thrustmaster)	3-7
Repair shop, floating, marine equipment, non-propelled, design 7011	3-53
Roll - on / roll-off discharge facility (RO/RO)	3-99
Side loadable warping tug (SLWT)	3-106
Tug, anchor handling / tug supply vessel	3-72
Tug, large, inland and coastal - 128 ft.	3-69
Tug, 200 horsepower, design 320	3-63
Tug, 600 horsepower, 100 ton, design 3004	3-57
Tug, 1200 horsepower, design 3006	3-60
Tug, rive, 50 ft., shallow draft, design 3013	3-67
Workboat, lifesaving and firefighting	3-35

**Index-2**

By Order of the Secretary of the Army:

Official:

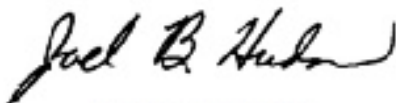

JOEL B. HUDSON  
*Administrative Assistant to the  
Secretary of the Army*  
02347

DENNIS J. REIMER  
*General, United States Army  
Chief of Staff*

DISTRIBUTION:

To be distributed in accordance with DA Form 12-34-E, block no. 0152, requirements for TM 55-500.

**These are the instructions or sending an electron 2028**

The following format must be us if submitting electronic 2028. The subject line must be exactly the same and all fields must be included; however the following fields are mandatory: 1, 3, 4, 5, 6, 7, 8, 9, 10, 13, 15, 16, 17, and 27.

From: "Whomever" <whomeveavma27.army.mil  
To: mpmt%avma28@st-louis-emh7.army.mil

Subject: DA Form 2028

1. **From:** Joe Smith
2. Unit home
3. **Address:** 400 Pad
4. **City:** Hometown
5. **St** MO
6. **Zip:** 777
7. **Date Sent** 19-OCT-9
8. **Pub no:** 55-2840-229-23
9. **Pub Title:** TM
10. **Publication Date:** 04JUL-85
11. Change Number. 7
12. Submitter Rank: MSG
13. **Submitter FName:** Joe
14. Submitter MName: T
15. **Submitter LName:** Smith
16. **Submitter Phone:** 12 -11234
17. **Problem: 1**
18. Page: 2
19. Paragraph
- 20.Line: 4
21. NSN: 5
22. Reference: 6
23. Figure: 7
24. Table: 8
25. Item: 9
26. Total 123
27. **Text**

This is the text for the problem below line 27.



## The Metric System and Equivalents

### *Linear Measure*

1 centimeter = 10 millimeters = .39 inch  
 1 decimeter = 10 centimeters = 3.94 inches  
 1 meter = 10 decimeters = 39.37 inches  
 1 dekameter = 10 meters = 32.8 feet  
 1 hectometer = 10 dekameters = 328.08 feet  
 1 kilometer = 10 hectometers = 3,280.8 feet

### *Weights*

1 centigram = 10 milligrams = .15 grain  
 inches  
 1 decigram = 10 centigrams = 1.54 grains  
 10.76 sq. feet  
 1 gram = 10 decigram = .035 ounce  
 sq. feet  
 1 decagram = 10 grams = .35 ounce  
 2.47 acres  
 1 hectogram = 10 decagrams = 3.52 ounces  
 mile  
 1 kilogram = 10 hectograms = 2.2 pounds  
 1 quintal = 100 kilograms = 220.46 pounds  
 1 metric ton = 10 quintals = 1.1 short tons

### *Liquid Measure*

1 centiliter = 10 milliliters = .34 fl. ounce  
 1 deciliter = 10 centiliters = 3.38 fl. ounces  
 1 liter = 10 deciliters = 33.81 fl. ounces  
 1 dekaliter = 10 liters = 2.64 gallons  
 1 hectoliter = 10 dekaliters = 26.42 gallons  
 1 kiloliter = 10 hectoliters = 264.18 gallons

### *Square Measure*

1 sq. centimeter = 100 sq. millimeters = .155 sq. inch  
 1 sq. decimeter = 100 sq. centimeters = 15.5 sq. inches  
 1 sq. meter (centare) = 100 sq. decimeters = 1,550 sq. feet  
 1 sq. dekameter (are) = 100 sq. meters = 1,076.4 sq. feet  
 1 sq. hectometer (hectare) = 100 sq. dekameters = 107,639 sq. feet  
 1 sq. kilometer = 100 sq. hectometers = 10,763,900 sq. feet

### *Cubic Measure*

1 cu. centimeter = 1000 cu. millimeters = .06 cu. inch  
 1 cu. decimeter = 1000 cu. centimeters = 61.02 cu. inches  
 1 cu. meter = 1000 cu. decimeters = 35.31 cu. feet

## Approximate Conversion Factors

<i>To change</i>	<i>To</i>	<i>Multiply by</i>	<i>To change</i>	<i>To</i>	<i>Multiply by</i>
inches	centimeters	2.540	ounce-inches	Newton-meters	.007062
feet	meters	.305	centimeters	inches	.394
yards	meters	.914	meters	feet	3.280
miles	kilometers	1.609	meters	yards	1.094
square inches	square centimeters	6.451	kilometers	miles	.621
square feet	square meters	.093	square centimeters	square inches	.155
square yards	square meters	.836	square meters	square feet	10.764
square miles	square kilometers	2.590	square meters	square yards	1.196
acres	square hectometers	.405	square kilometers	square miles	.386
cubic feet	cubic meters	.028	square hectometers	acres	2.471
cubic yards	cubic meters	.765	cubic meters	cubic feet	35.315
fluid ounces	milliliters	29.573	cubic meters	cubic yards	1.308
pints	liters	.473	milliliters	fluid ounces	.034
quarts	liters	.946	liters	pints	2.113
gallons	liters	3.785	liters	quarts	1.057
ounces	grams	28.349	liters	gallons	.264
pounds	kilograms	.454	grams	ounces	.035
short tons	metric tons	.907	kilograms	pounds	2.205
pound-feet	Newton-meters	1.356	metric tons	short tons	1.102
pound-inches	Newton-meters	.11296			

### Temperature (Exact)

°F      Fahrenheit      5/9 (after      Celsius      °C  
temperature      subtracting 32)      temperature

PIN: 013725-000